

4G Cellular IoT Modbus RTU



S272 User Manual

Ver 2.7

Date Issued: 2020-07-22

King Pigeon Hi-Tech. Co., Ltd.

www.iot-solution.com



Table of contents

1.	Brief Introduction -----	3
2.	Safety Directions-----	4
3.	Standard Packing List-----	4
4.	Main Features-----	5
5.	Physical Layout and Installation Diagram&Wiring-----	6
6.	Settings & Operations -----	11
7.	Example Of Applications-----	33
8.	Device SMS Command and SMS APP-----	53
9.	Device GPRS/3G/4G Communication Protocol-----	57
10.	Upgrade Firmware-----	73
11.	Cellular Module Upgrade-----	73
12.	Warranty-----	73

This handbook has been designed as a guide to the installation and operation of S272

GSM/SMS/GPRS/3G/4G Cellular IoT Modbus RTU

Statements contained in the handbook are general guidelines only and in no way are designed to supersede the instructions contained with other products.

We recommend that the advice of a registered electrician be sought before any Installation work commences.

King Pigeon Hi-Tech.Co., Ltd, its employees and distributors, accept no liability for any loss or damage including consequential damage due to reliance on any material contained in this handbook.

King Pigeon Hi-Tech.Co., Ltd, its employees and distributors, accept no liability for GSM Network upgrading or SIMCard upgrading due to the technology specifications contained in this handbook.

【UPGRADE HISTORY】

DATE	CONFIGURATOR VERSION	FIRMWARE VERSION	HARDWARE VERSION	DESCRIPTION
2018.12.13	V2.5	V2.5	V2.4	1.DIN status revised to reverse from V2.4 version, only support V2.5 configurator software. 2.The total value range function of DIN1 pulse count upgraded.
2020.7.22	V2.7	V2.7	V2.6	1. Add DIN1-3 pulse counter 2. Add MQTT

Model List

Model	DIN	AIN	DO	Temp& Humi	SD card	USB	RS485	Mapping Registers			
								Boolean	16Bit	32Bit	64Bit
S272	8	6	4	1	8G	1	1	64	64	×	×
S275	8	6	4	1	8G	1	1	64	128	64	64



Notice

- 1.Default version is GSM/GPRS module inside.
- 2.For 3G WCDMA, 4G LTE version, please tell our sales where would you like to use them.

1. Brief introduction

The Cellular IoT Modbus RTU is an industrial class, high reliability, high stability, and programmable Remote Terminal Unit (RTU). It embedded 32-Bit High Performance Microprocessor MCU, inbuilt industrial Cellular module. It provides 8 digital inputs, 6 analog or PT100 Resistance Temperature Detector (RTD) inputs, 4 relay outputs, 1 ambient sensor input for monitoring onsite temperature and humidity, and RS485 serial port, supports 80/224/320 mapping registers via Modbus RTU protocol. It can monitoring and operates the I/O ports by SMS, APP, Web Server, internet, timers and programmed inter-lock events automatically.

The Cellular IoT Modbus RTU inbuilt TCP/IP protocol stack make it suitable for internet of things (IoT) applications, it can be easily to operate by the provided cloud, app, and web server, or integrated to you IoT applications according to the TCP/UDP protocol, or integrated to SCADA systems by standard Modbus TCP protocol, too. This is very useful if you need remote control onsite devices with low cost solution.

The Cellular IoT Modbus RTU is design for working in the harsh industrial application environment, widely used in a variety of industrial automation, security monitoring system, automatically measurement and control system, BTS monitoring, remote data acquisition, telemetrically systems, automatically control system. It can be used as a remote switch, remote I/O, remote smart PLC, timer switches.

The Cellular IoT Modbus RTU can be used as remote access control for BTS monitoring, the authorized users can open the gate or turn on the machine with a free charge call at specified time, this is useful for daily maintenance to save the time of traditional authorized.

The Cellular IoT Modbus RTU supports transparent data transmission and performs as Modbus Slave over GPRS/3G/4G network and RS485 serial port. Moreover, the Cellular IoT Modbus RTU can be used as Modbus RTU Master to reading smart meters, I/O modules, PLC, and converts to SMS alert once triggered the threshold value, or transmit data to remote server over GPRS/3G/4G network.

Typically applications:

BTS Monitoring, Security Alarm System applications, Supervision and monitoring alarm systems, Automatic monitoring system, Vending Machines security protection, Pumping Stations, Tanks, Oil or Water levels, Buildings and Real Estate, Weather Stations, River Monitoring and Flood Control, Oil and gas pipelines, Corrosion protection, Temperatures, water leakage applications, Wellheads, boat, vehicle, Energy saving, street lights control system, Valve controls, Transformer stations, Unmanned machine rooms, Control room application, Automation System, M2M, Access Control System, etc.



KING PIGEON

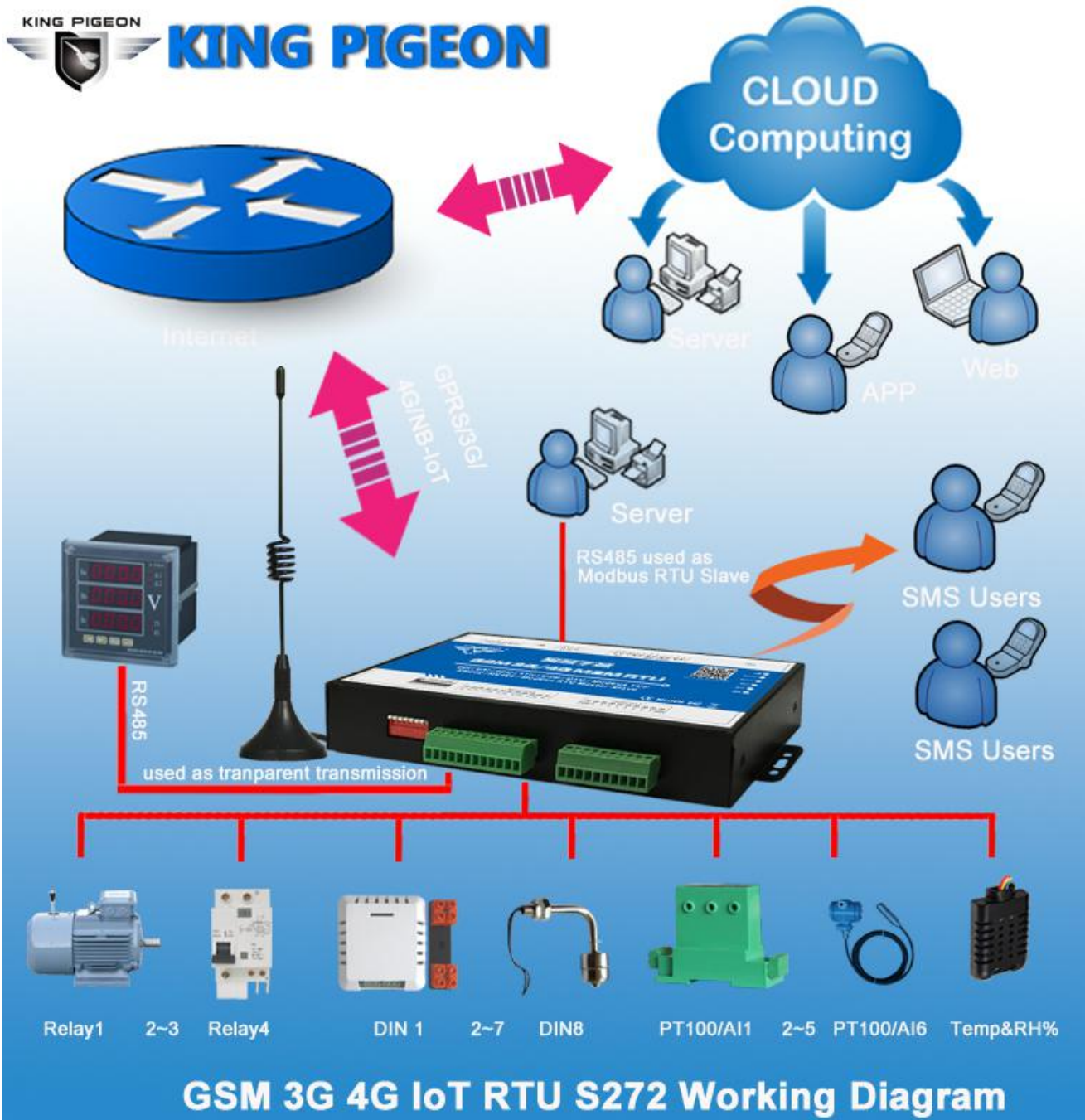

2. Safety Directions



Safe Startup

Do not use the unit when using GSM/3G/4G equipment is prohibited or might bring disturbance or danger.



Interference

All wireless equipment might interfere network signals of the unit and influence its performance.

3. Standard Packing List

Gateway X1; AC/DC Adaptor X1; GSM/3G/4G Antenna X1; User Manual X1; PC Configurator X1 .

Note: The package does not include any SIM card.

Optional: 35mm Standard DIN rail fixed Bracket

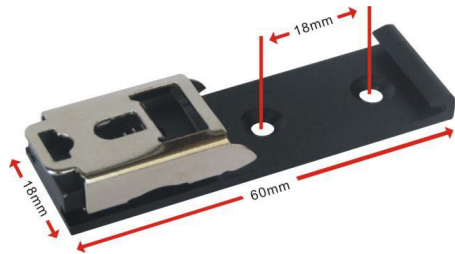

35mm DIN Rail Fixed Bracket

4.1 Main Features

- GSM/GPRS/3G/4G network communication, can be operated from anywhere, no distance limitation;
- Wide range power supply 9~36VDC with over voltage and phase-reversal protection;
- Embedded ARM[®] Cortex[™] -M4 32 Bit RISC Core, 168 MHz inside, RTOS system, reliable performance with in-built watchdog;
- 8 digital inputs, compatibles dry and wet contact. Logic level: 0~0.5V or short circuit treated as close, +3~30V or open circuits treated as open. DIN0 as a high-speed pulse counter, sampling frequency: 1MHz; DIN1~3 as low-speed pulse counter, anti-shake time can be set 1~2000ms, default 1ms;
- DIN1 as arm and disarm function;
- 4 relay output (5A/30VDC, 5A/250VAC), can auto control by timer, alarm-link and remote control by SMS, cloud. The first DO can set time to control by authorize number;
- 1 temperature & humidity sensor input for monitoring onsite environment, the sensor model is AM2301, Measures temperatures from -40~80°C, 0.5°C accuracy, Relative Humidity from 0~99RH%, accuracy is 3%;
- 6 analog inputs, 12bits resolution, supports 0-5V, 0-20mA, 4-20mA output transducers;
- Inbuilt 8G SD card to save up to tens of thousands historical data and events;
- 1 RS485 port, support Modbus slave protocol, can link up to SCADA、HMI、DSC. Support Modbus Master protocol, can extend up to 16 Modbus Salve device, e.g.: Data Acquisition Module, meters, generator, PLC, VFD, etc., and 128 mapping registers can set alarm value and content, also support data transparent transmission;
- Powerful SMS function: Threshold high SMS alert, SMS set, SMS inquiry, SMS command for Modbus PLC..., and SMS monitoring communication with Slaves;
- Inbuilt 2 DC output for external transducers to save wiring cost;
- Automatically resend the data while communication interrupt or failure, and failure will alert by SMS text to users;
- Supports remotely restart the RTU, and configure& operate it by SMS commands remotely;



- 10 SMS Alert and auto dial numbers for receiving alarm message, can program to receive specified alarm message. The authorized numbers also can dial to open the door or turn on/off machine with a free charge call at the specified time;
- Inbuilt inter-lock logic programmer and powerful timer program function;
- Modular structure design, replace a module can upgrade the network from 2G to 3G/4G or 3G to 4G;
- Support SMS, dial, GPRS, 3G , 4G network for alert, USB port for configuration and upgrade firmware;
- Inbuilt large capacity automatically rechargeable backup battery, alert when external power failure;
- Support TCP/UDP, MQTT, Modbus TCP, Modbus RTU over TCP, King Pigeon IoT RTU protocol and data transparent transmission function;
- Using metal shell, protection class IP30. Metal shell and system security isolation, especially suitable for industrial applications in the field;
- L195 * W88 * H30mm, compatible wall installation and DIN35mm industrial rail installation.

4. 2 Specifications

Item	Reference Scope
DC Power supply	Standard adapter: DC 12V/2A Range 9-36VDC
Power consumption	Standby:12V/50mA; Working Max.: 12V/150mA
GSM Frequency	850/900/1800/1900Mhz
3G/4G	Optional: WCDMA/TDD-LTE/FDD-LTE
TCP/IP stack	TCP,UDP
SIM interface	Supporting 3V and 1.8V SIM Card
External antenna	SMA Antenna interface, 50 Ohm, Gain: 3dB
Serial Interfaces	1 USB Port
Protocols	SMS, GPRS UDP, TCP, MQTT, Modbus RTU over TCP and King Pigeon RTU protocol.
RS485	1 RS485, Support Transparent transmission and Modbus RTU Slave, Modbus RTU Master.
Digital Inputs	8 Digital input, NC/NO type, one of it can be used as Pulse Counters;
Analog Inputs	6 Analog Inputs. 12 bit resolution, 0-5V or 0-20mA or 4-20mA;
Temp.&Hum Inputs	Temperature range: -40°C to +80°C, Humidity Range: 0~100%RH;
Relay Outputs	4, Rated: 5A/30VDC, 5A/250VAC
Power Outputs	2 Port, for external device;
Extend I/O Tags/Mapping Registers	Max.128
Memory Capacity	Internal 8G SD card inside, can save the data for 100000events.
Backup Battery	3.7V 900mAH
Temperature range	-20-+70 °C
Humidity range	Relative humidity 95% (condensation free)
Exterior dimension	195mm*88mm*30mm
Net Weight	350g

5. Physical Layout and Installation Diagram&Wiring

5.1 Control Unit size and physical layout

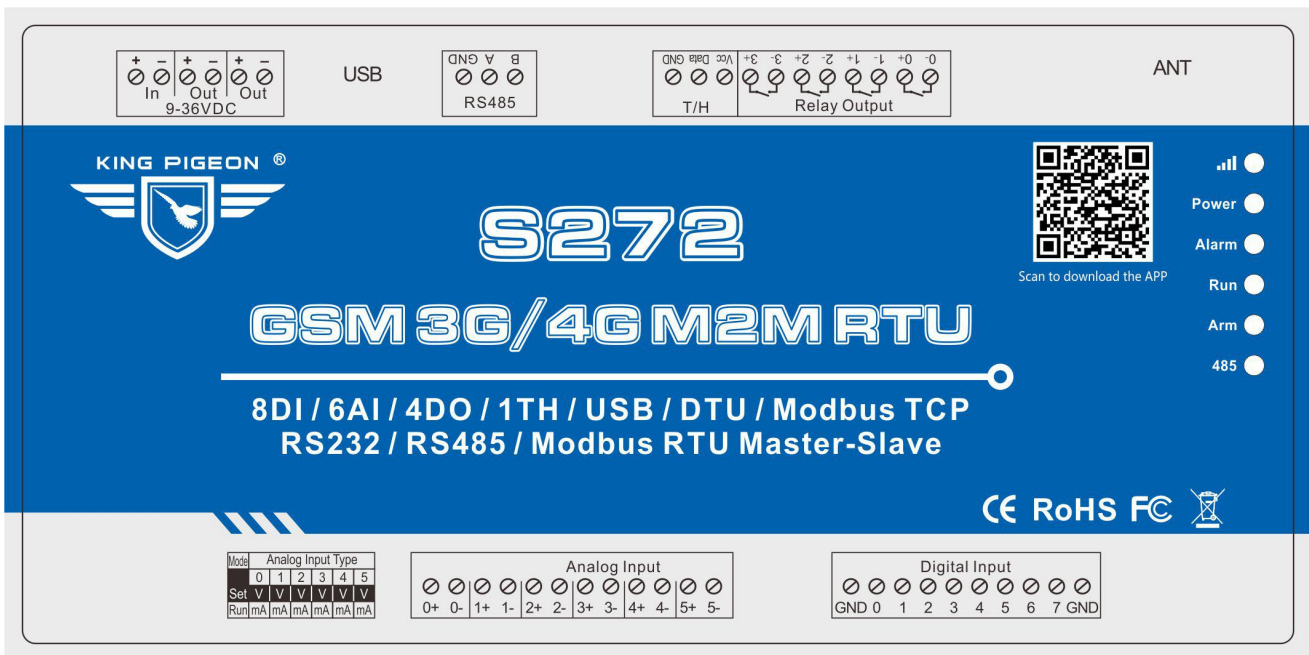
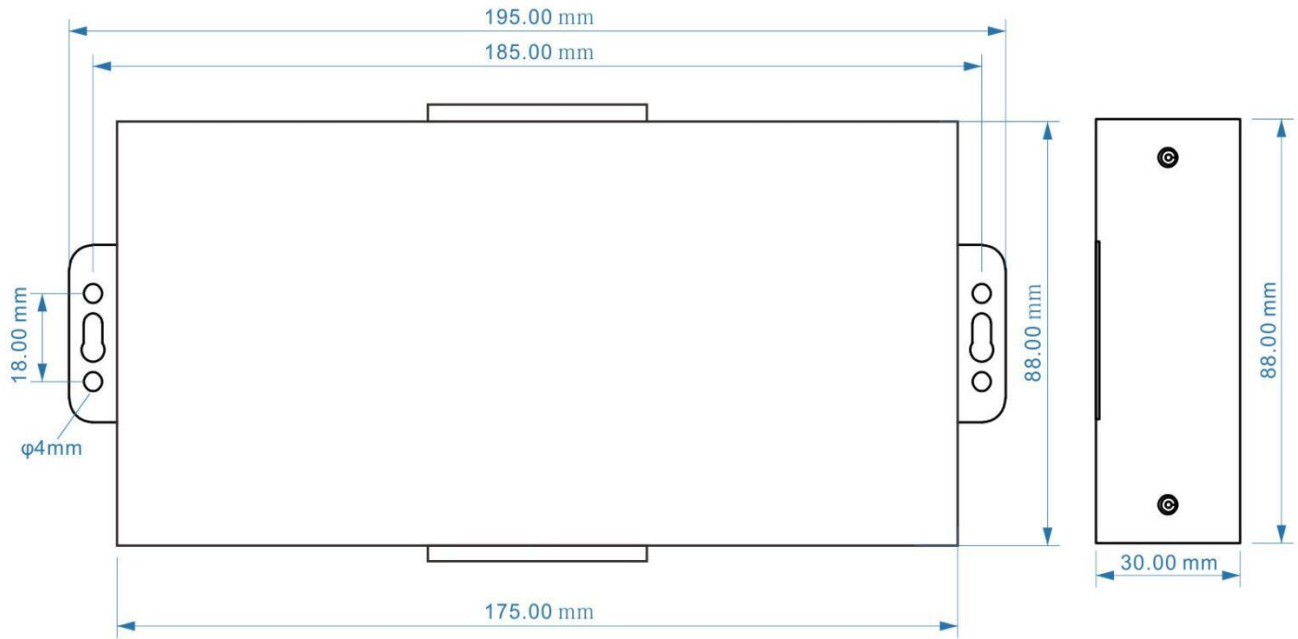

LED Indicator Definition

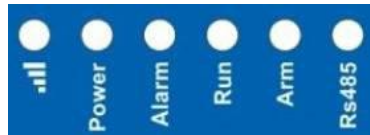

Power	RTU status indicator, LED ON when switched RTU on..
	Cellular network indicator. When 2G register network, off 2 seconds, on 0.5s and so on; When 3G 4G register network, on 2s, off 0.5s...Flicks quickly means data transmission.
Alarm	Alarm Indicator, alarm will ON and flick. Normally is OFF;
Arm	Arm/Disarmed Indicator, Arm is ON, disarmed is OFF.

Run	RTU running status indicator, ON or OFF stands for RTU halted, flicks slowly stands for RTU running.
RS485	When transmitting data by RS485, the LED will flick, otherwise, it is off.

Backside Switch & Button Definition

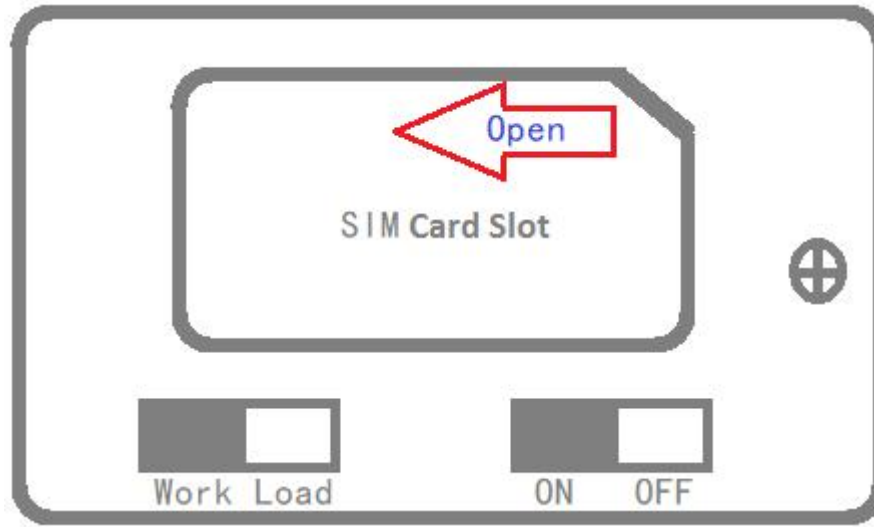

SIM Card Slot	For SIM Card Installation, only supports 1.8V/3V SIM Card
Power Switch	For switch ON or OFF the RTU
Upgrade Firmware Switch	For upgrade firmware purpose only. Only when upgrade new firmware version will use it, otherwise keep it at Work Side all the time.

Power Connector Definition

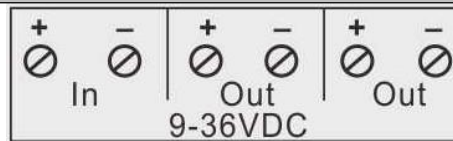





DC IN+	External DC Power input port, Connect to 1.5A@9~36V DC power, positive electrode.
DC IN-	External DC Power Input port, contact to negative electrode
DC Out+	Power source output port, positive electrode. Provides power from RTU to external transducers or sensors or detectors. The output current should less than the power from DC IN inputs. If adapter current is 2A, then suggest external transducer current to be less than 1.5A
DC Out -	Power source output port, Negative electrode.

DIP Switch Definition

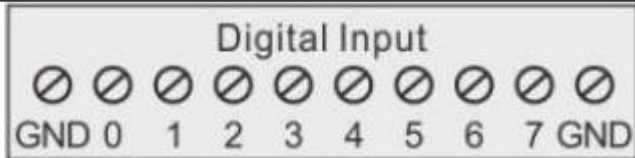
Mode	Analog Input Type					
	0	1	2	3	4	5
Set	V	V	V	V	V	V
Run	mA	mA	mA	mA	mA	mA

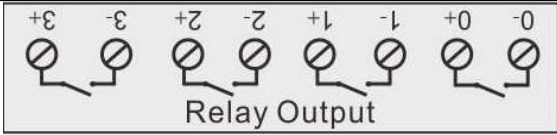
SET/RUN	For setting the RTU Mode is in Configuration Mode or Run mode. Switch it to upside is Set Mode, under this mode, the user can use PC Configurator via USB cable to configure the RTU Parameters or Read Parameter settings. Switch it to Downside is Run Mode, under this mode, the RTU is in Running mode. Tips: When device mode changed, need to switch off/on the device.
0/V/mA	The 1 st channel of analog input type switch. If not use this channel then no matter is upside or downside. Switch it to upside stands for the 1 st analog input should connect to 0~5V voltage output transducer. Switch it to Downside stands for the 1 st analog input should connect to 0~20mA or 4~20mA current output transducer.

	Tips: <i>The wrong side will cause device can't read the analog value.</i>
1/V/mA~5/V/mA	<p>The 2nd to 6th channel of analog input type switch. If not use this channel then no matter is upside or downside.</p> <p>Switch it to upside stands for the related analog input should connect to 0~5V voltage output transducer.</p> <p>Switch it to Downside stands for the related analog input should connect to 0~20mA or 4~20mA current output transducer.</p>
Analog Input Definition	
	
<p><i>Analog inputs, Sampling frequency 200mS, 12bits resolution, supports 0-5V, 0-20mA, 4-20mA output transducers, please refer to above mentioned DIP Switch Definition to connect the correct transducers.</i></p>	
0+/0-	The 1st Channel Analog input. + stands for positive electrode, - stands for negative electrode.
1+/1- ~5+/5-	The 2 nd ~6 th Channel Analog input. + stands for positive electrode, - stands for negative electrode.
Digital Input Definition	
	
<p><i>Dry contact or wet contact, sampling frequency 200mS. Logic level: 0~0.5V or short circuit treated as close, +3~30V or open circuits treated as open. One of the input can be used as counter, sampling frequency is 1Mhz, the second input can be used for Arm/Disarm.</i></p>	
0	The 1st digital input, positive electrode.
1~7	The 2 nd ~8 th digital input, positive electrode.
GND	GND for digital inputs, negative electrode.
ATN Port Connector Definition	
ATN	GSM/3G/4G Antenna connector, 50Ohm, SMA male.
USB Port Connector Definition	
USB	USB port, for configuration and upgrading firmware and exporting historical data;
Temperature Humidity Sensor Port Definitions	
	
T/H	Temperature & Humidity sensor AM230x input. Measurement Range: Temperature: -40°C to +80°C, Humidity: 0~100%RH.
Digital Solid Relay Output Connector Definition	
	
<p><i>Solid Relay inside for outputs, Rated Capacity: 5A/30VDC, 5A/250VAC.</i></p>	
0+/0-	The 1st Channel Solid Relay Output. + stands for positive electrode, - stands for negative electrode.
1+/1- ~ 3+/3-	The 2 nd ~ 4 th Channel Solid Relay Output. + stands for positive electrode, - stands for negative electrode.
RS232/RS485 Ports Definition	

	
GND	Ground
A/B	RS485 A / B

5.2 Wiring

T&H

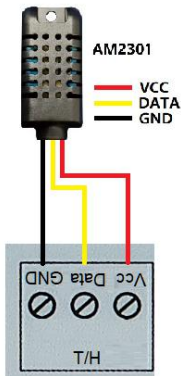

Relay Output

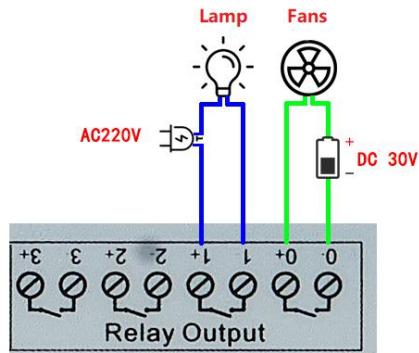

Wet contact input

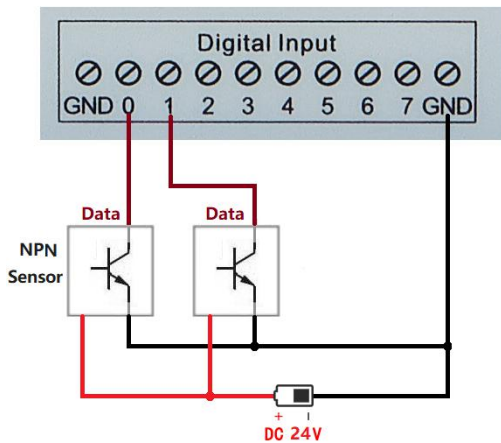

Dry contact input

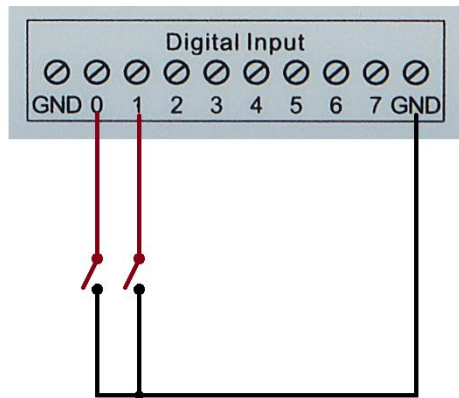

RS485

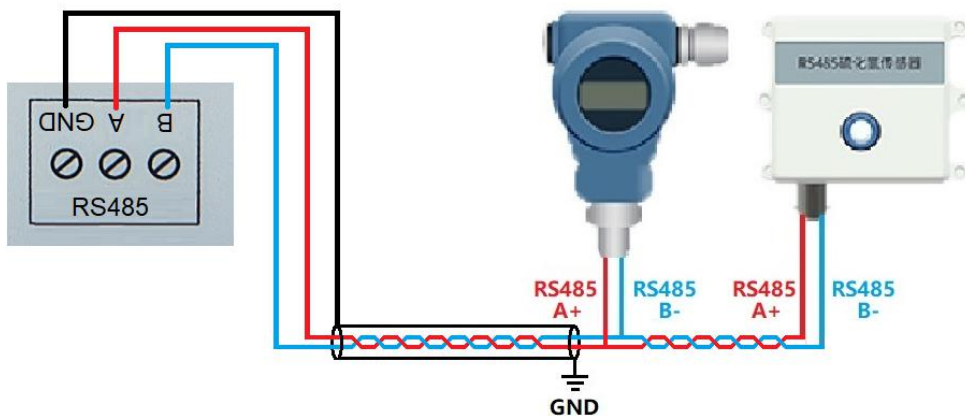

Analog Input

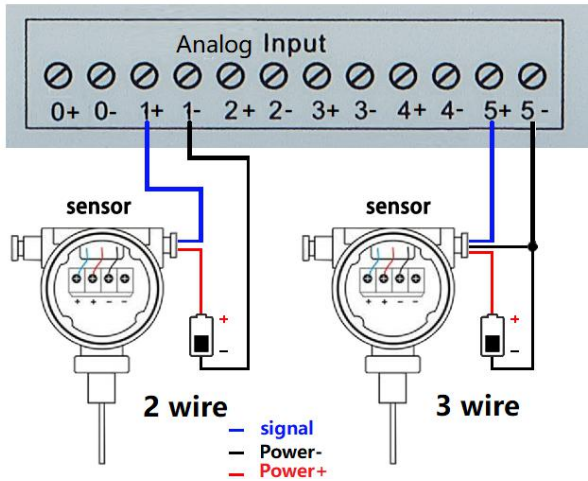

Analog Input

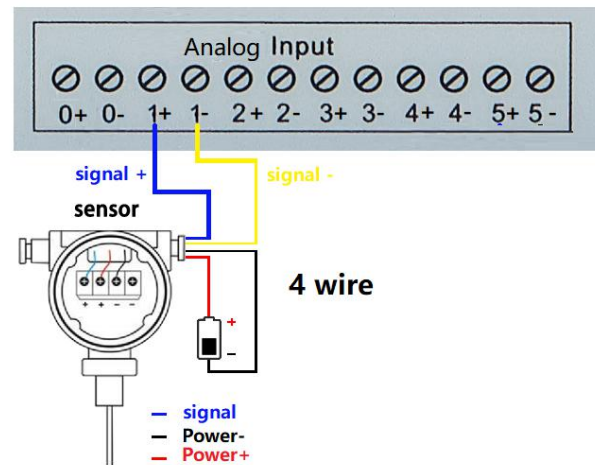

6. Settings & Operation

The GSM SMS GPRS 3G 4G Cellular IoT Modbus RTU is user-friendly design. The user can setup it or export historic data by the PC Configuration through USB cable, and upgrade firmware by USB port. The GSM SMS GPRS 3G 4G Cellular IoT Modbus RTU also can be configured some basically parameters by SMS Commands, please refer to SMS Command App or [Command List](#).

Tips!

- 1) Please insert the SIM Card firstly, and install the GSM/3G/4G Antenna, please power on to check the LEDs status according to above mentioned LED Definitions, keep switch on it during the programming.
- 2) The PC Configuration in the CD, please click it to run it. Also can download from www.GPRS-M2M.com under S273/4/5 page directly.

Below is the steps to setup the parameters by PC Configuration, please follow it step by step.



Start to Configure:

Step1: Install the Configurator

Download from www.GPRS-M2M.com, then installs it on the computer.

Step2: Connection

Please insert the SIM Card, and install the GSM/3G/4G Antenna.

Step3: Switch the DIP Switch to Setup Mode. (Before Power On the RTU)

Switch it to upside is Set Mode, under this mode, the user can use PC Configurator via USB cable to configure the RTU Parameters or Read Parameter settings.

Notice:

Please switch it to Downside after you finished the configurations. Otherwise, the RTU cannot work properly. The Downside is Run Mode, under this mode; the RTU is in Running mode.

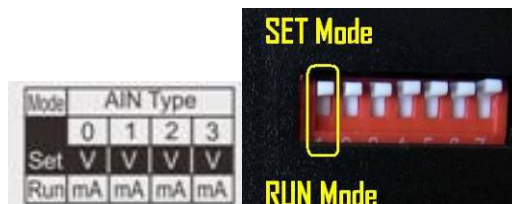

Step4: Connect the Gateway to the PC by USB Cable. And connect the external DC Power to DC Power Ports, Power on, and switch on the device, see below:

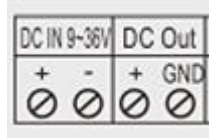

Step5: Install USB Driver

Install the USB Driver to the computer . When successful, it can be found out at the device manager of the XP or Windows 7 or Win8/Win10, please see the below photo. Also, the driver for different OS can be downloaded from Silicon Laboratories, Inc. <http://www.silabs.com> , the model is CP210x.

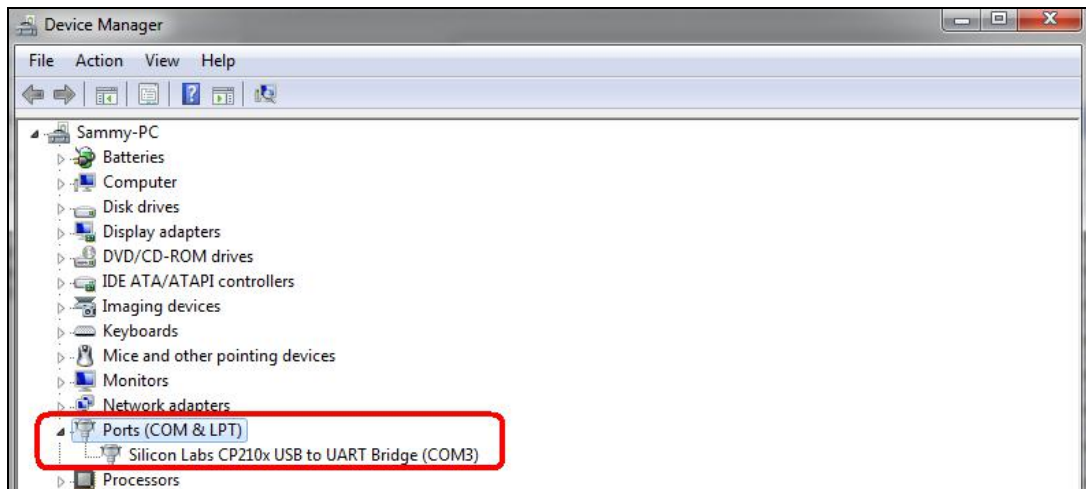

Step6: Run the Configurator (Compatible with Windows XP/7/8/10)

Tips: In some computer, it required download net framework 4.0 while installation, then please click "Yes" to go to Microsoft website to download this service pack.



Please click  to run it. Enter the password, default is 1234. Then you can enter the configuration page as below:

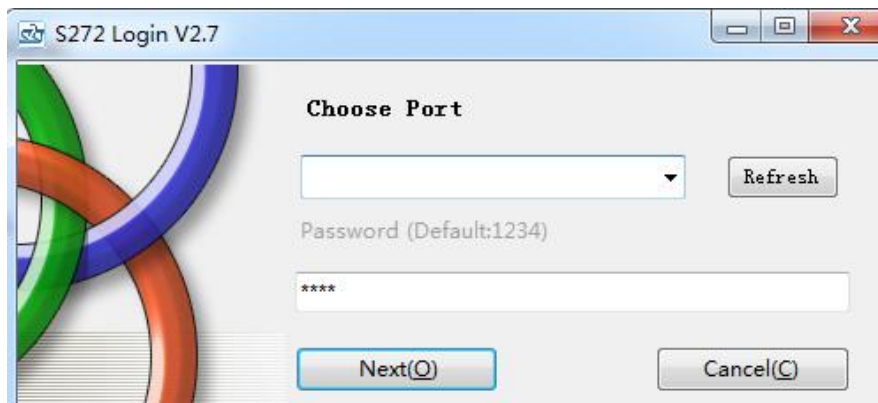

Notice:

If display the below windows, then means the RTU connect to the PC failure. The reasons are below:

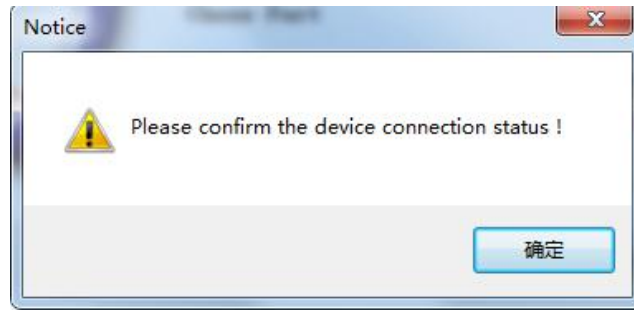

- 1) USB Driver installation failure;
- 2) USB Cable connection is disconnected;
- 3) The DIP Switch in RUN mode, not in SET mode;
- 4) The Upgrade Firmware Switch at Load side, not at Work side.
- 5) Power Switch switched off or DC Power Connection is disconnected.

Step7: Choose the correct "COM port" in device manager above, enter the password(default is 1234),click the "OK" to connect and start to program

Details please check the picture as below:

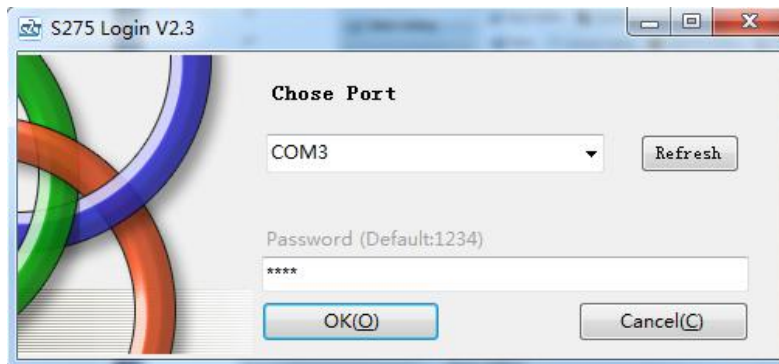

Tips: If not connect successfully, will not enter into next step. Pls check if USB connect well, or COM port and password correct or not.

Setting Self-checking

Phenomenon	Possible Reason
Can't enter software	<ol style="list-style-type: none"> 1. USB Driver installation failure; 2. COM Port not correct or USB driver installation failure; 3. Device not enter into setting mode: <ol style="list-style-type: none"> 1) Only power light on, that means the Upgrade Firmware Switch at Load side, not at Work side. Solution: Switch the power switch to OFF----> Upgrade switch to Work side----> Power switch to ON. 2) Signal light flicks, that means device in working mode. Maybe had not rebooted the device after switch mode switch to Set. (In setting mode, Power light normal ON, Run light flicks, other lights Off.)
After switching panel on, only Power light on, panel can't work	<ol style="list-style-type: none"> 1. The Upgrade Firmware Switch at Load side, not at Work side. Solution: Switch the power switch to OFF---->Upgrade switch to Work side----> Power switch to ON; 2. SD card fall out from the slot. Solution: Shake panel to listen if there is voice or

	<p>not;</p> <p>3. In upgrade mode, use upgrade tool erased the firmware.</p>
<p>Can't enter into working mode</p>	<p>1. The Upgrade Firmware Switch at Load side, not at Work side. Solution: Switch the power switch to OFF---->Upgrade switch to Work side----> Power switch to ON;</p> <p>2. Device in setting mode. Solution: Switch device OFF---->Mode switch to "Run"---->Switch the device on.</p>
<p>Can't find COM Port</p>	<p>1. Have not installed driver;</p> <p>2. PC system problem cause driver installation failure, can't support Apple OS system.</p> <p>3. Check USB line, and try other common driver software such as "Drive TheLife".</p>
<p>In working mode, the device not response the Modbus command</p>	<p>Have not set the device ID. Solution: In setting mode, set device ID---->Switch the device to Run mode.</p>
<p>After switching panel on, not running according to parameter setting</p>	<p>After parameter setting, although clicked "Save" in every page, but missed the final "Save Setting" in the menu. Solution: Back to Set mode---->Click "Save" Button after setting one page---->After all page set successfully, click "Save Setting" in the menu.</p>

Terms usually used by Cellular IoT Modbus RTU

Cellular IoT RTU, MQTT, Modbus RTU, Modbus Master, Modbus Slave, Modbus RTU Over TCP, Modbus TCP, Arm, Disarm...

Configurator software interface and running

Select SIM card category, then enter setting.

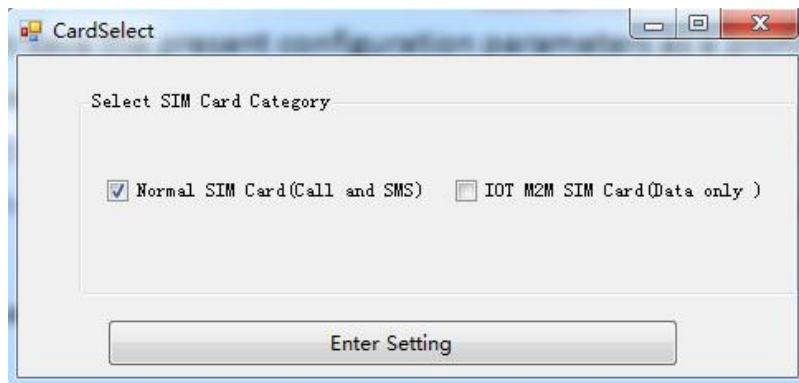

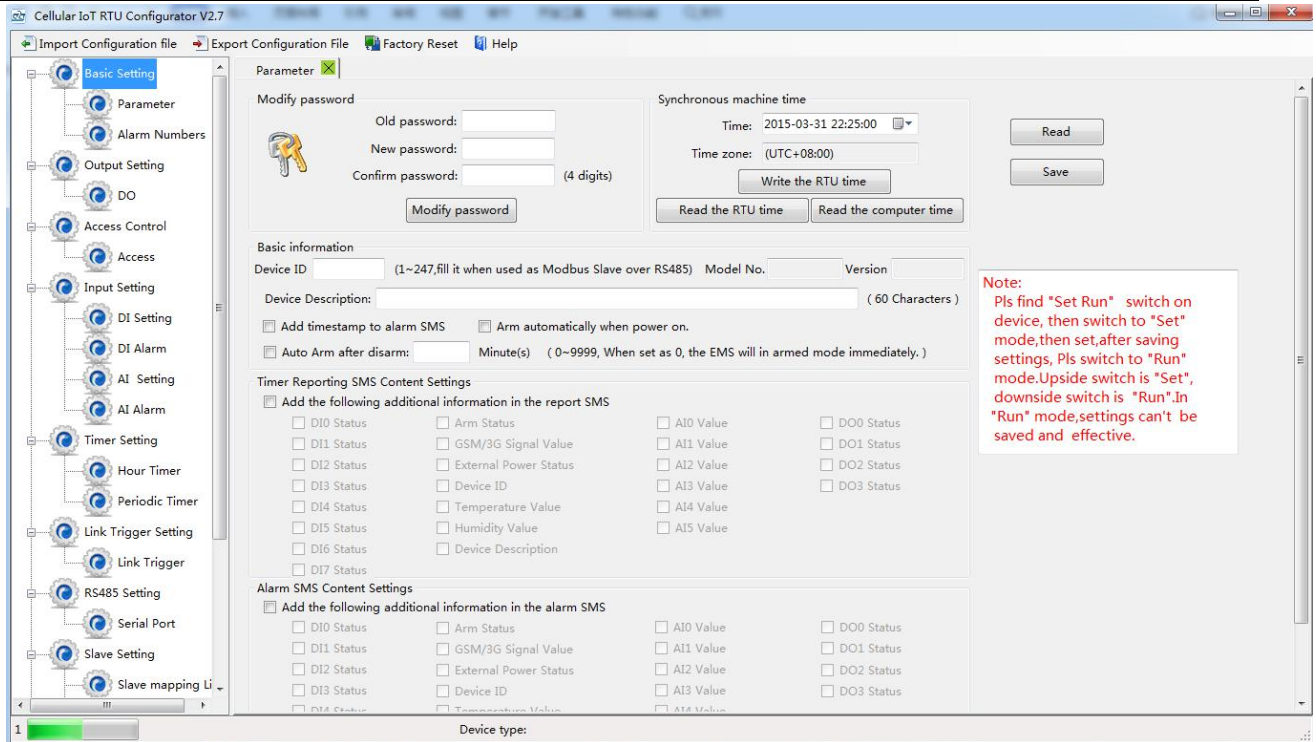

Save : Click it to save all of the PC Configurator parameters to the RTU;

Import Configuration file: Click it to load additional configuration file to the Configurator;

Export Configuration file: Click it to save the present configuration parameters as a profile for next RTU configuring or backup the parameter settings.

Tips: The Import and export configuration file is very useful while you need to program bulks of RTU with similar parameters.

After programmed the first unit then you can export profile to save it, for the second RTU then you can load profile directly to save you time.

Factory Reset: Click it to recovery the parameters to factory defaults.

Notice:

1. After setting or revising parameter, need to click the "Save" button of this page, then click "Save Settings" in menu for saving parameters in device
2. Before S272 export configuration, need to read Slaves configuration details first, to avoid Slaves information missing.
3. Easy way to revise parameter: Open parameter setting page---->Click "Read" button to get device current value ---->Revise and click "Save" button---->Click the "Save Settings" button in the menu.
4. Switch the device mode to "Run" as below, otherwise it will not work;



5. Reboot the device, switch the Power Switch to OFF, then switch it to ON, the device will enter into normal run mode after that

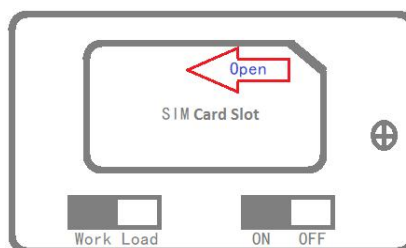



Basic Settings

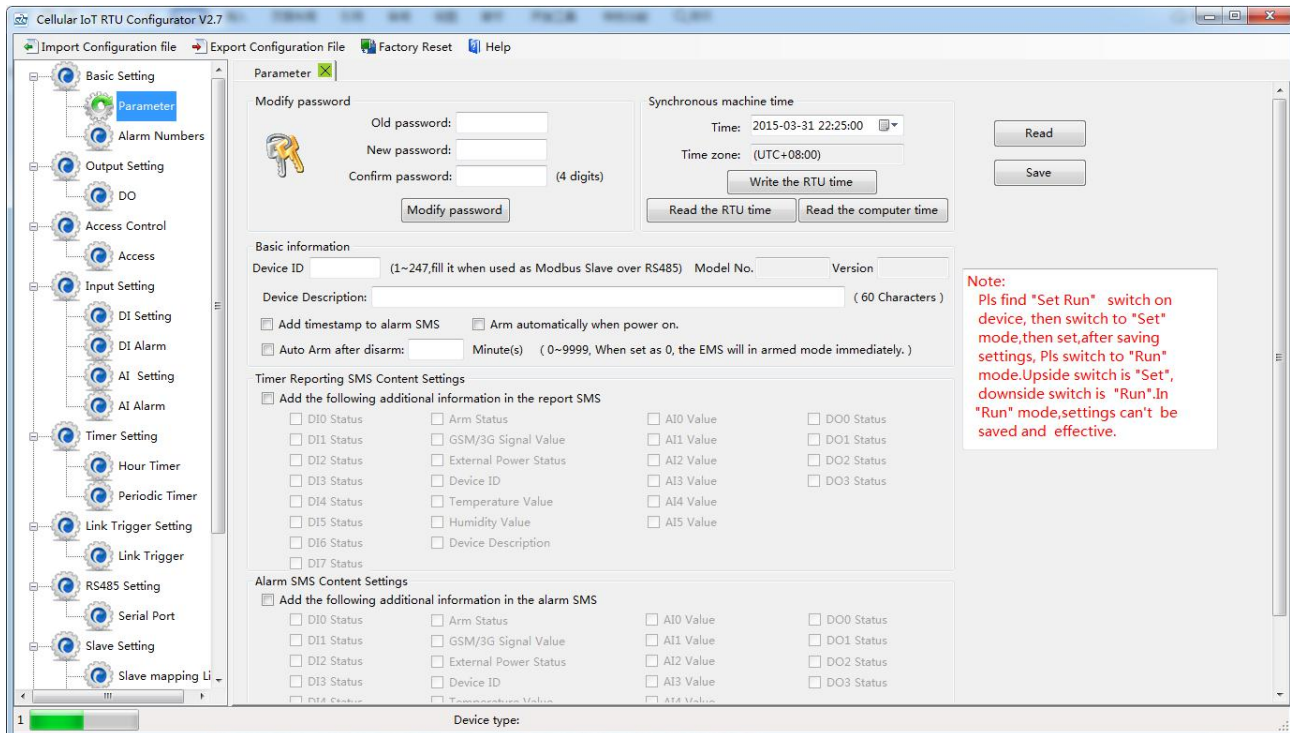

Reminder: Please click the "Read" for previous parameter before starting to set.

Modify Password: This is for modifying the RTU's Password, default is 1234.

Synchronous device time: This is to setup the RTU's time for daily report or other timers. After click **Write the RTU Time**, the RTU will be synchronous the same time as the PC. If connect to King Pigeon Cloud Server, no need this step.

Device ID: Non-necessary. This is mainly for monitoring center to identify the RTU; If communicate via Modbus protocol, device ID only can be 1~247.

Device description: This is the description of the RTU, e.g.: installation address, usage instructions and so on.

Add Timestamp to Alarm SMS: Tick it stands for while alarm occurrence, the Alarm SMS will include the RTU'S current time information at the SMS Content.

Arm automatically when Power On: Tick it stands for once the RTU powered up, the RTU will enter into Arm Mode automatically.

Auto Arm after Disarmed: Fill the timeout to enter into Armed Mode automatically after disarmed operation. This is useful for security protection applications.

Tips:

Arm: Under this mode, any alarm occurrence will send SMS and dial the authorized numbers immediately. And execute the programmed I/O outputs.

Disarmed: Under this mode, alarm occurrence will not send SMS & dial the authorized numbers.

Timer Reporting SMS Content Settings: Tick the related items to add its value/status to the Timer report SMS contents.

Alarm SMS Content Settings: Ticks the related items to add its value/status to the Alarm SMS Contents.

Alarm Number Settings

This is to setup the Authorized User Telephone Numbers to receive the Alarm SMS or dial. Tick it stands for while the related event alarm occurrence will send SMS to this number.

Reminder:

Please remember that click "Save" -" Save Settings" button to save it after parameter be written, below pages are the same.

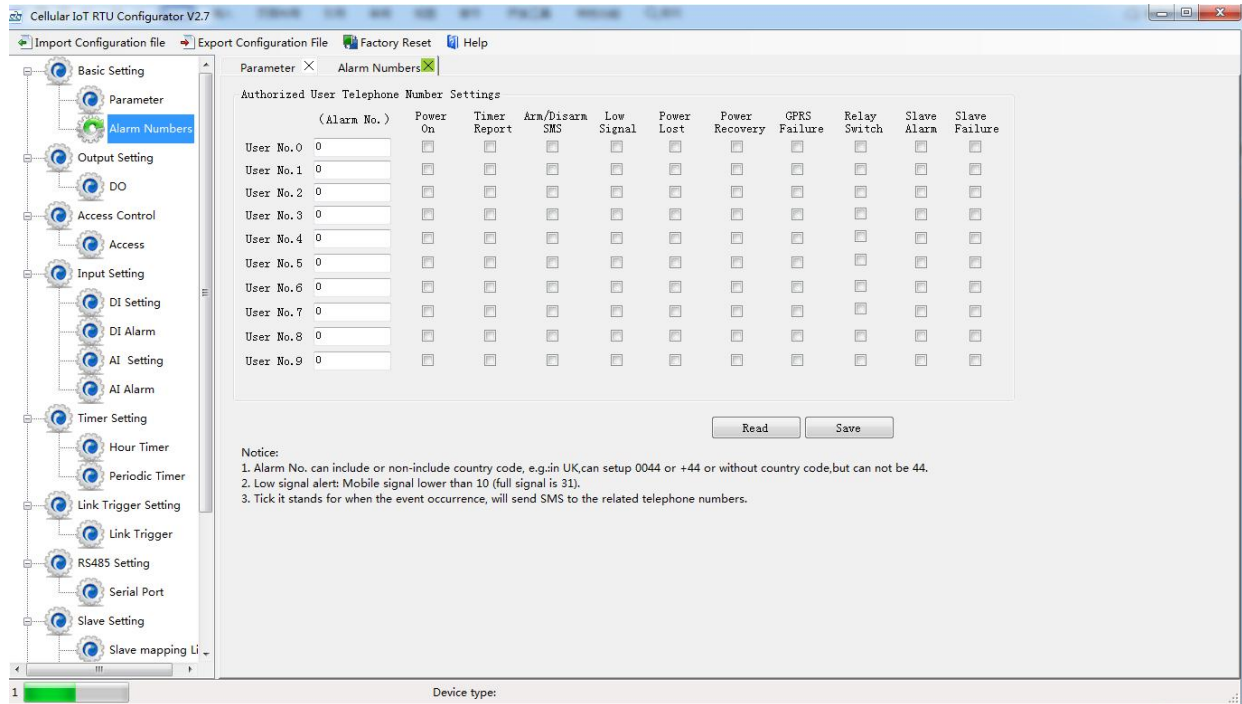

Power On: Tick it stands for while the RTU powered up, will automatically send SMS to this number, include device model, version, description, IMEI, status, signal value etc....

Timer Report: Tick it stands for Timer report SMS will send to this number.

Arm/Disarm: Tick it stands for Arm or Disarm the RTU, will send SMS to this number.

Low Signal: Tick it stands for while GSM/3G/4G Network signal strength lower than 14 will send SMS to this number.

Power Lost: Tick it stands for while external DC Power loss will send SMS to this number.

Power Recovery: Tick it stands for while external DC Power recovery, will send SMS to this number.

GPRS Failure: Tick it stands for while GPRS connection re-try 3 times and still failure will send SMS to this number.

Relay Switch: Tick it stands for while the Digital Solid Relay Output action will send SMS to this number.

Slave Alarm: Tick it stands for the slave tag triggered will send SMS to this number.

Slave Failure: Tick it stands for when slave communication failure alarm verify time arrive, will send SMS to this number.

Digital Solid Relay Output Settings

This page is to setup the Output parameters and definite the output usages. The outputs will be used

in the Interlock Page for programmable logic events.

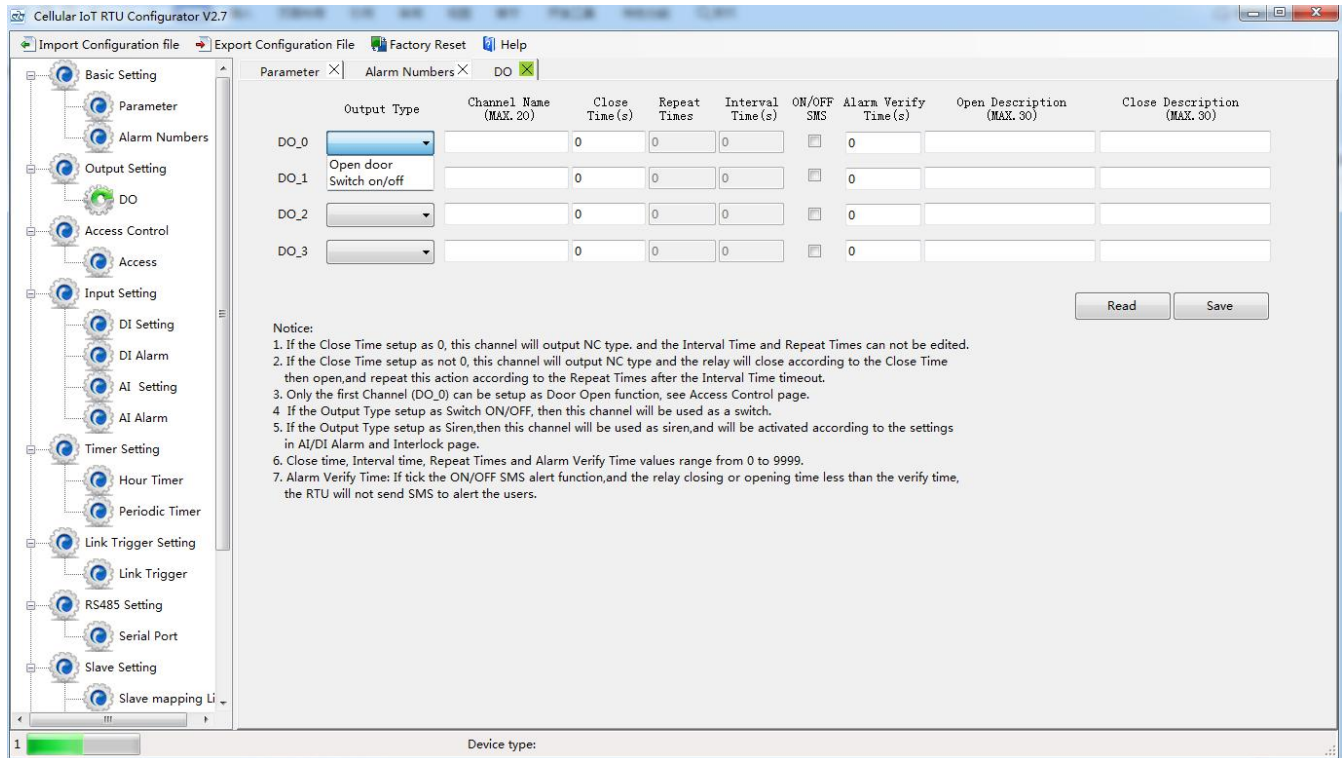

Output Type: Support 3 output types. The user can choose the Output Type for the relay outputs, includes Open Door, Switch ON/OFF, Siren. The relay 2 and 3 only used for Switch ON/OFF; Relay 0 can be optional as Open Door and Switch ON/OFF; Relay 1 can be optional as Siren and Switch ON/OFF.

- 1) **Open Door:** Only the first Channel(DO0) can be setup as Open Door, use it for electric lock. If setup as Open Door, then the authorized number calls in RTU, can open the electric Lock directly or output a pulse signal and disarmed the RTU directly. See **Access Control** page about the authorized number.

Notice:

If relay 0 used for Open Door, then can't be action as normal Switch ON/OFF.

Application:

When RTU installed in generator room, many workers out and in, not convenience and safe for everyone taking keys. This function can authorize the person to remotely control the door and disarm the device within appointed time, avoid fault anti-thief alert. After worker maintenance the generator room, can touch the inside Arm/Disarm switch button to arm device, DIN2 can do this.

- 2) **Switch ON/OFF:** For switch on/off device.
- 3) **Siren:** This is for output pulse signal for siren sounds, If setup as Siren, then while the RTU alarm and ticked the Siren function in AIN or DIN trigger pages, then this channel will execute the setting parameters.

Channel Name: to setup the Output Channel name, e.g.: Pump or Motor and so on, in order to identify it in SMS Contents.

Open Description: Stands for when the Relay Open, send what SMS to the authorized numbers;

Close Description: Stands for when the Relay Close, send what SMS to the authorized numbers.

Close Time: Stands for the relay close and last time, default 0 second, means always close.

Repeat Times: Stands for how many times does this relay should to repeat.

Interval Time: Stands for interval how many seconds then the relay repeat the action again.

Match with "Repeat Times" can work as pulse output, unit: second.

ON/OFF SMS: Tick it stands for while the Recovery action, will also send SMS to the authorized numbers;

Access Control Setting

This page is for setting which authorized number at what time can dial to the RTU and let the first channel (DO0) output a pulse output.

Only when the output types of the first channel (DO0) setup as **Open Door** can dial to control it.

It is very useful for serviceman dial to open the electric lock door and disarmed at specified time of the Room. Also this function can be used as authorized number dial in the RTU to output a pulse output or always close then call again open the relay at specified time. In this condition, please setup the output type of DO0 as **Open Door**, and setup other parameters correctly, and remember to setup the **Auto Arm after Disarmed** time as 0 to keep the RTU in Armed Mode if required.

Tick the box ahead the User No. stands for enable the first Authorized number can dial in to let the first channel (DO0) output a pulse output.

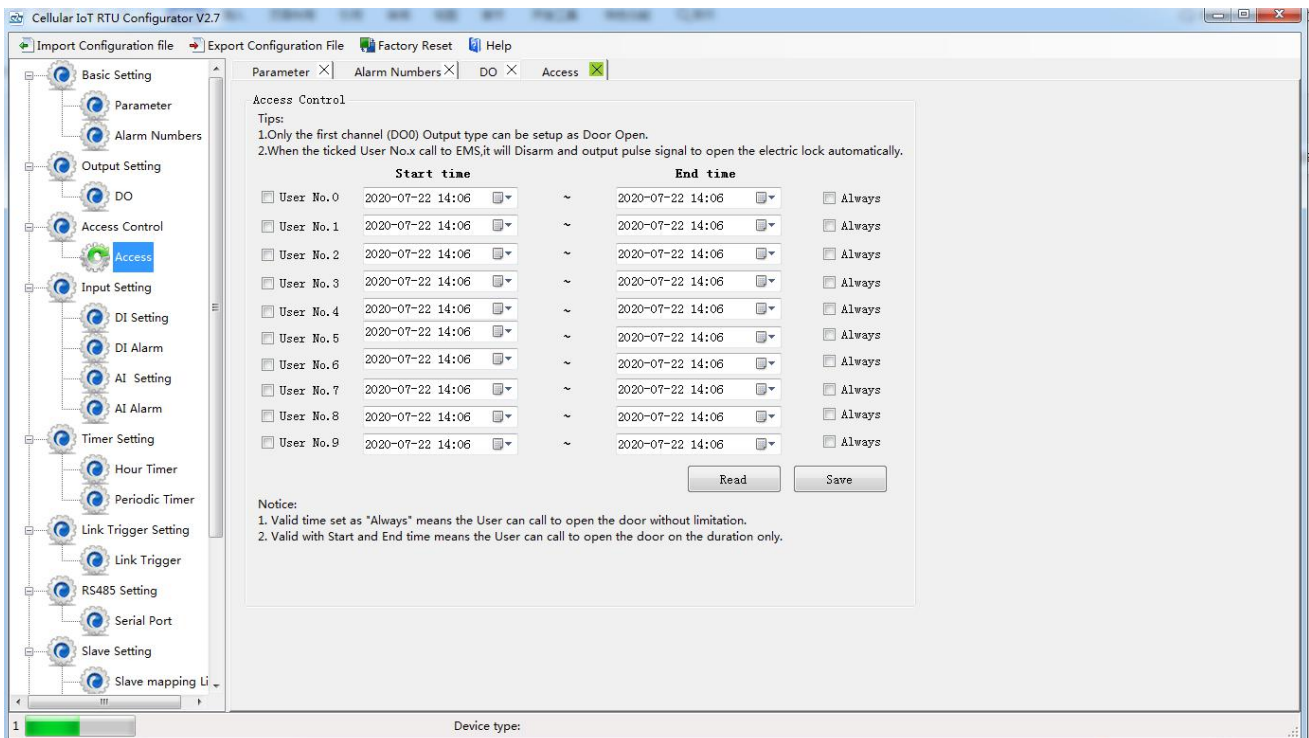

Start Time: Stands for from what time this authorized number can dial in to control it.

End Time: Stands for till what time this authorized number cannot dial in to control it.

Always: Stands for this authorized number can dial in to control it all the time.

DI Setting

This page is for setting the digital input alarm conditions and usages.

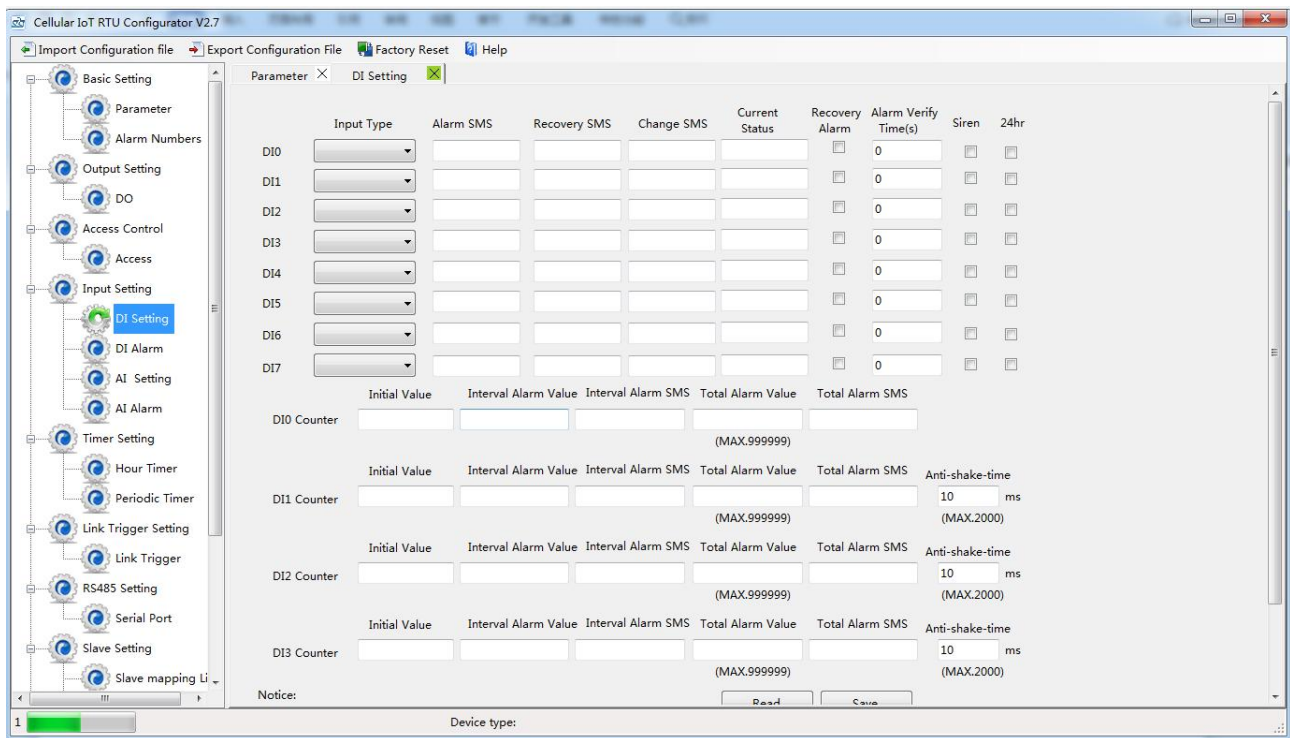

Input Type: The user can choose the input type for related channel. Includes: Counter, Arm/Disarm, NC, NO, Change and Disabled.

- 1) **Disabled:** Not use this channel.
- 2) **NC:** For connecting Normal close type detector, open will alarm.
- 3) **NO:** For connecting normal open type detector, close will alarm.
- 4) **Change:** For connecting normal open or normal close type detector, once the status changed, will be treated as alarm.
- 5) **Counter:** DI0 as a high-speed pulse counter, sampling frequency: 1MHz;
DI1~3 as low-speed pulse counter, anti-shake time can be set 1~2000ms, default 1ms;
Need to tick up the Pulse Counter box to setup initial value and interval alarm value and total alarm value. E.g.: contact a PIR sensor to count how many people pass through the ATM machine and so on.
- 6) **Arm/Disarm:** Only the Second Channel (DI1) can be used as Arm/Disarm Switch. For connecting a pulse output type switch to Arm or Disarmed the RTU.

Alarm SMS: Under Arm or 24h status, once triggered will send this SMS content to authorized numbers.

Recovery SMS: Under Arm or 24h status, if tick the "Recovery Alarm", when triggered digital input recovery normal will send this SMS content to authorize number.

Change SMS: Under Arm or 24hr status, only when digital input choose "Change" type, once action will send this SMS to authorize number.

Current Status: Stands for input's current status.

Alarm Verify Time: Stands for when the digital input Close or Open last time more than this value, will be treated as a true alarm, if less than this value, then will not alarm.

Siren: Tick it stands for while this digital input triggering, the DO that output type was setup as Siren will execute its output parameters.

24Hr: Tick it stands for no matter the RTU is in Arm or Disarmed mode, this digital input triggered

will alarm.

Initial Value: When DIN0 as counter, the value begin to count.

Interval Alarm Value: DIN0 as counter, under Arm or 24hr status, when counter value arrive "Interval Alarm Value" will send SMS to authorize number.

Total Alarm Value: When counter value arrive "Total Alarm Value", will automatically refresh it to "Initial Value". Under Arm or 24hr status, will call and SMS to authorize number.

Interval Alarm SMS: When interval alarm, will send this SMS to authorize number.

Total Alarm SMS: When arrive total max value, will send this SMS to authorize number.

DI/AI Alarm Settings

This page is for setup while DI/AI alarm, send SMS & Dial to which authorized numbers. Tick it stands for enable to send SMS or dial the related authorized number, see below page is for DI settings, the AI Alarm Settings is the same:

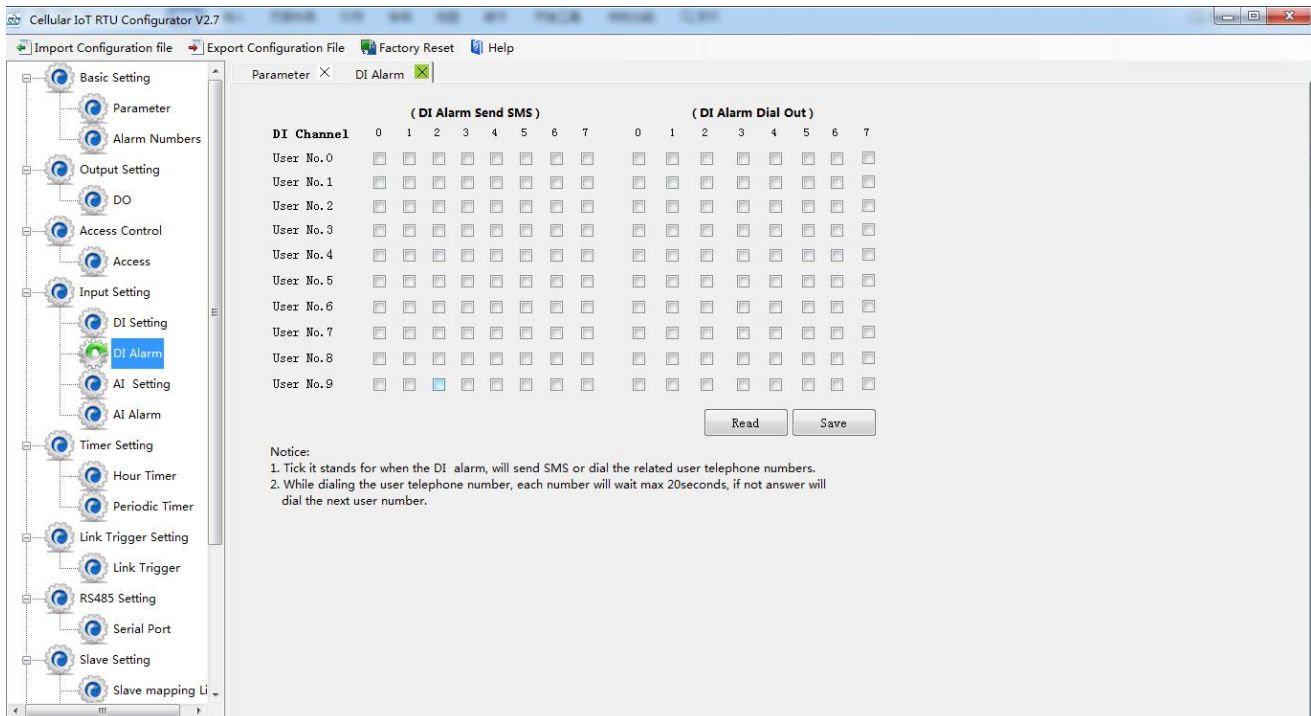

AI Trigger Setting

This page is to setup the analog input alarm conditions and analog input parameter. AIN can be used for monitoring temperature, current, voltage, power factor, water level, pressure, environment, wind speed... And also one channel temperature and humidity transducer can be connected as below:

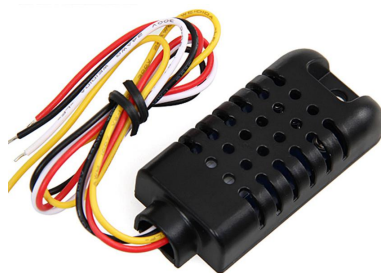

AM2301 PIN Dfinition

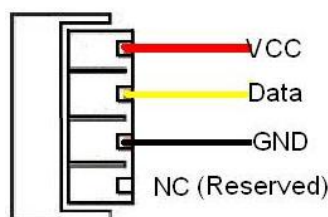

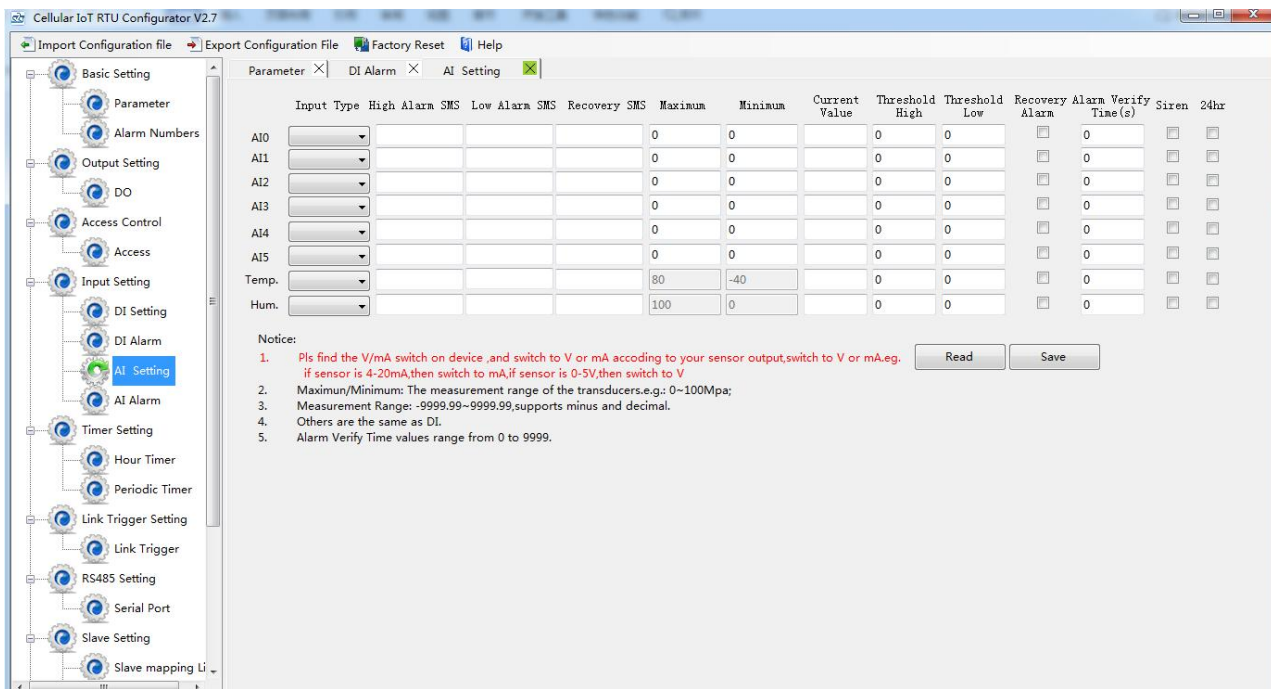

Input Type: The user can choose the input type for related channel. Includes: Disable, 0~5V, 0~20mA, 4~20mA.

- 1) **Disabled:** Not use this channel.
- 2) **0~5V:** For connecting transducers that output voltage 0~5V. Please remember to switch the related channel DIP switch to V side, see **DIP Switch Definitions**.
- 3) **0~20mA:** For connecting transducers that output current 0~20mA, Please remember to switch the related channel DIP switch to A side, see **DIP Switch Definitions**.
- 4) **4~20mA:** For connecting For connecting transducers that output current 0~20mA, Please remember to switch the related channel DIP switch to A side, see **DIP Switch Definitions**.
- 5) **Temperature and Humidity:** Enable/Disable support. Only accept AMS230x series sensor, the temperature maximum is 80, minimum is -40, and Humidity maximum is 100, minimum is 0, cannot change them.

High Alarm SMS: Under Arm or 24h status, once current value higher than threshold high value will send this SMS content to authorized numbers.

Low Alarm SMS: Under Arm or 24h status, once current value lower than threshold low value will send this SMS content to authorized numbers.

Recovery SMS: Under Arm or 24h status, if tick the "Recovery Alarm", when current value recovery normal will send this SMS content to authorize number.

Maximum: The transducer's maximum measure range. E.g.:100 Celsius degree. Usually it can be found out at the transducer's specification.

Minimum: The transducer's minimum measure range. E.g : -50 Celsius degree. Usually it can be found out at the transducer's specification.

Current Value: Stands for input's current value of the transducers.

Threshold High: The high value(reached) need to alarm; Example: set 50Celsius degree to alert.

Threshold Low: The low value(reached) need to alarm; Example: set -30Celsius degree to alert.

Recovery Alarm: Tick it stands for when the analog input recovery, will send SMS to the authorized numbers.

Siren: Tick it stands for while this input triggering, the DO that output type was setup as **Siren** will execute the its output parameters.

24Hr: Tick it stands for no matter the RTU is in Arm or Disarmed mode, this input triggered will alarm.

Timer Setting

This page is for setup hour timer and periodically timer, it is useful for scheduling when to execute what action automatically or it with repeat this action according to the interval time. Total can program 10 scheduling events. Tick it stands for enable this timer event:

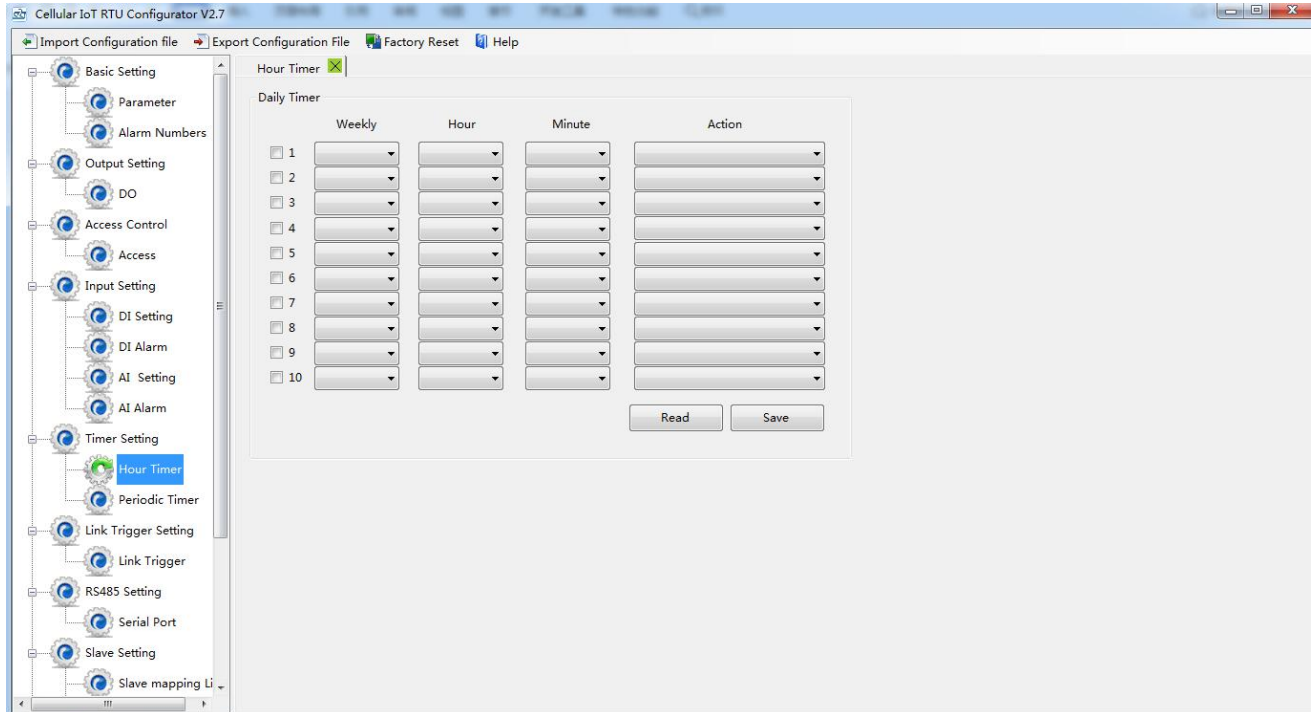

Reminder:

When GPRS/3G/4G data transmission protocol is King Pigeon IoT RTU Protocol, the periodically auto upload default enable and upload every 5 minutes.

Tick stands for enable this timer function, otherwise is disable.

Weekly+Hour+Minute: Stands for what day and at what time does the RTU should start to execute the action and interval how many seconds then repeat to execute the action.

Interval: Stands for interval how many seconds does the RTU should repeat to execute the action. If setup it as 0, then this event will not be repeated.

Action: Stands for what action does the RTU should to execute at the specified time.

Question: Have set the timer SMS report, but finally not get the SMS.

Solution: Have no ticked the "Timer Reporting SMS Content" in first Basic Parameter Settings page.

Logic Trigger Setting

This page is for setup if what happen, then what action does the RTU should execute, it is a programmable logic events. Total can program up to 40 logic events for automatically control purposes.

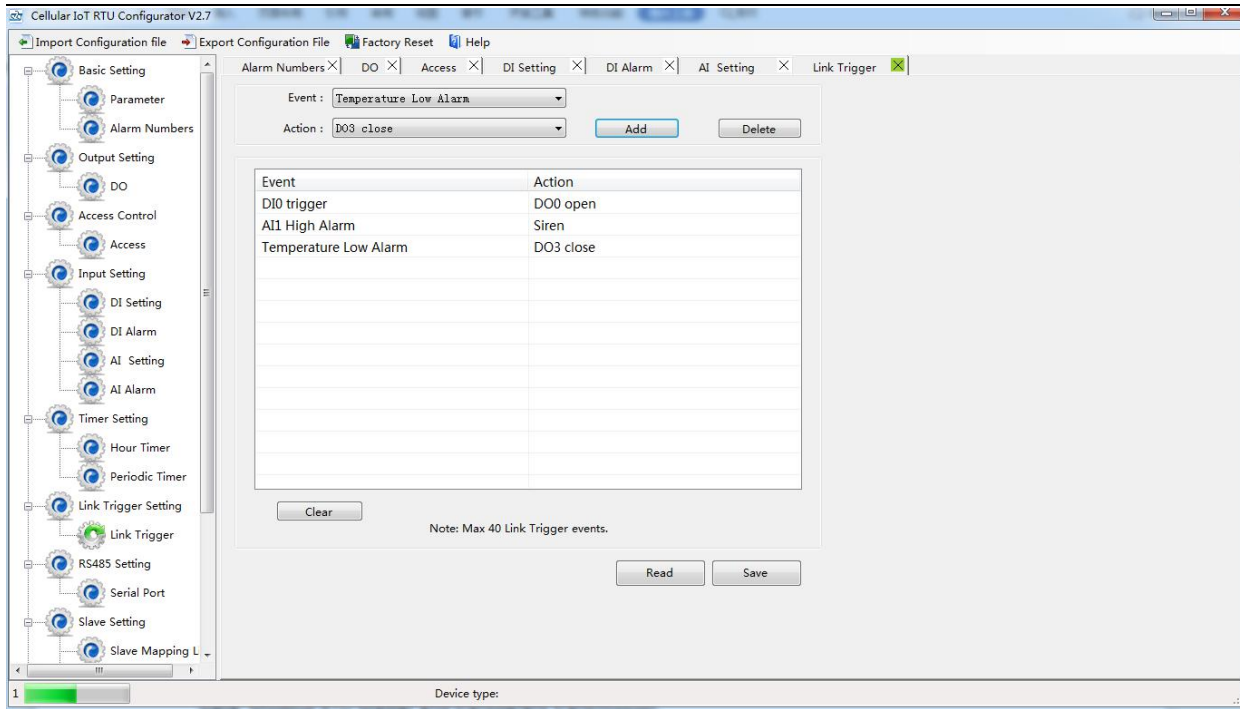

Event: Stands for if this occurrence.

Action: Stands for then what action does the RTU should execute.

RS485 Serial Port Setting

This page is for setup the serial port parameters. Over the RS485, the S272 RTU can be used as Modbus RTU Slave, Modbus RTU Master and transparent transmission.

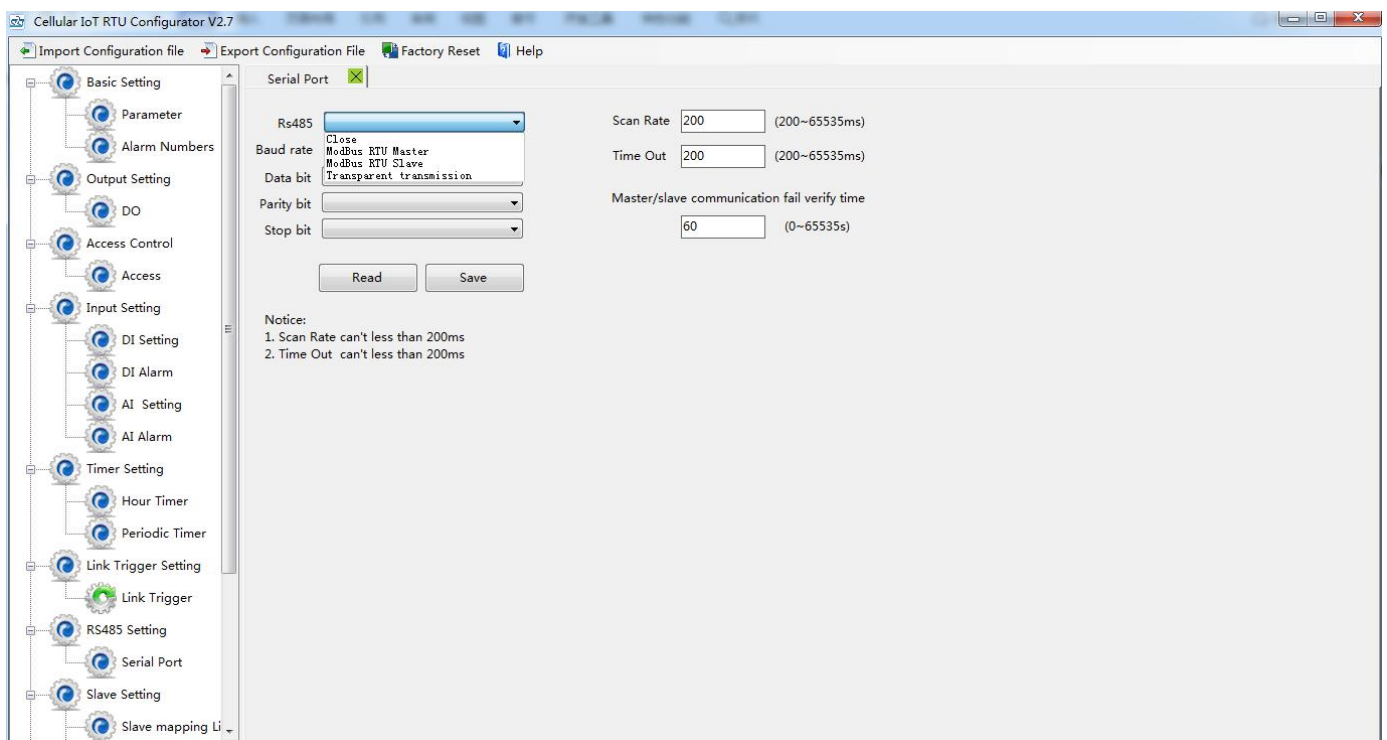

Modbus RTU Master: Stands for the RS485 used for Modbus RTU Master.

Modbus RTU Slave: Stands for the RS485 used for Modbus RTU Slave, and the "Scan rate", "Time out" and "Slave failure verify time " of Master function will be disable.

Baud Rate: 1200/2400/4800/9600/19200/38400/57600/115200 optional.

Data Bit: 8 bit.

Parity Bit: None, Even and Odd optional.

Stop Bit: 1 or 2 stop bit optional.

Scan rate: When RS485 used as Master, the interval time between two polling command.

Time out: When RS485 used as Master, after sending command to slave, the longest time waiting for slave data back. If longer than this setting value, will ensure slave no response.

Slave failure verity time: When RS485 used as Master, if no response time between Master and Slave longer than this value, will send SMS to authorize number.

 **Modbus RTU Slave function:**

When RS485 as Modbus RTU Slave, can be connected to HMI, SCADA, DCS, PLC... as below:

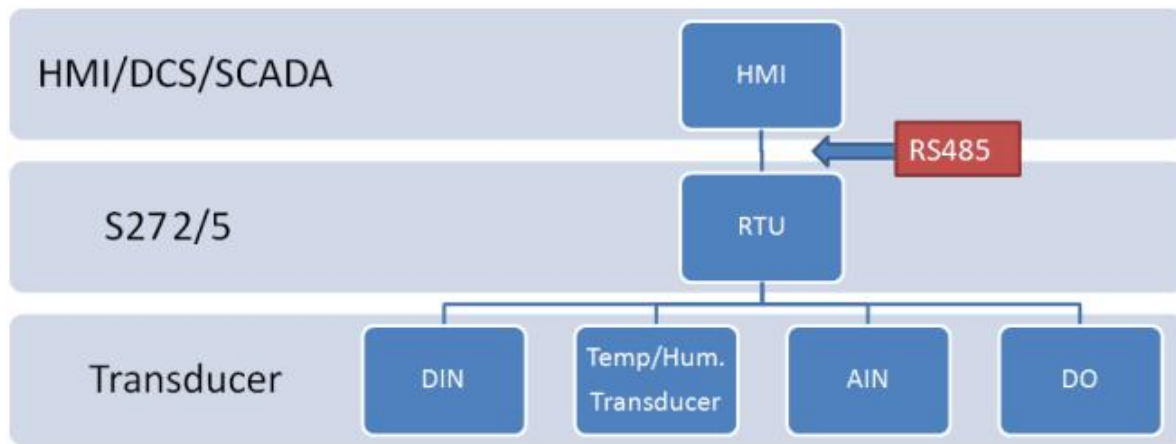

RTU I/O Register List and function code:

Read Input Coil (Function Code 02: Read Coil)		
Register Address (Decimal)	Definition	Description
0	RTU DIN0	DIN0 value, when dry contact, NC=1, NO=0; When wet contract, 0~0.5V=1, 3~24V=0
1	RTU DIN1	DIN1 value, when dry contact, NC=1, NO=0; When wet contract, 0~0.5V=1, 3~24V=0
2	RTU DIN2	DIN2 value, when dry contact, NC=1, NO=0; When wet contract, 0~0.5V=1, 3~24V=0
3	RTU DIN3	DIN3 value, when dry contact, NC=1, NO=0; When wet contract, 0~0.5V=1, 3~24V=0
4	RTU DIN4	DIN4 value, when dry contact, NC=1, NO=0; When wet contract, 0~0.5V=1, 3~24V=0
5	RTU DIN5	DIN5 value, when dry contact, NC=1, NO=0; When wet contract, 0~0.5V=1, 3~24V=0
6	RTU DIN6	DIN6 value, when dry contact, NC=1, NO=0; When wet contract, 0~0.5V=1, 3~24V=0
7	RTU DIN7	DIN7 value, when dry contact, NC=1, NO=0; When wet contract, 0~0.5V=1, 3~24V=0

Read Input Register (Function Code 4: Read Input Register.)



Register Address (Decimal)	Definition	Data Type	Description
0	RTU AIN0	32 Bit Signed ABCD 1 Byte in Modbus protocol	AIN0 value, real value= AIN0 value/100
2	RTU AIN1		AIN1 value, real value= AIN0 value/100
4	RTU AIN2		AIN2 value, real value= AIN0 value/100
6	RTU AIN3		AIN3 value, real value= AIN0 value/100
8	RTU AIN4		AIN4 value, real value= AIN0 value/100
10	RTU AIN5		AIN5 value, real value= AIN0 value/100
12--13	(reserved, not work)
14	RTU Power	16 Bit Unsigned AB 1 Byte in Modbus protocol	External power voltage, real value= Power value/100
15--23	(reserved, not work)
24	RTU Temperature	16 Bit Signed AB 1 Byte in Modbus protocol	AM2301 Temperature value (*100), real value= Temperature value/100
25	RTU Humidity	16 Bit Signed AB 1 Byte in Modbus protocol	AM2301 Humidity value (*100), real value= Humidity value/100.
26	RTU DIN0 Count Value	32 Bit Unsigned	This value Enable when DIN0 as counter mode

Read and Write Holding Coil (Function Code 1, Function Code 5, Function Code 15.)		
Register Address (Decimal)	Definition	Description
0	RTU DO0	DO0 Value, Read/Write, 1=Close, 0=Open
1	RTU DO1	DO1 Value, Read/Write, 1=Close, 0=Open
2	RTU DO2	DO2 Value, Read/Write, 1=Close, 0=Open
3	RTU DO3	DO3 Value, Read/Write, 1=Close, 0=Open
4--63	(reserved, not work)	



Transparent Transmission:

The RS485 can be used as transparent transmission, transmit the device data on this serial port to GPRS/3G/4G, the device not deal with or store any data, only do as a data transmit channel, converter serial port to TCP/IP.

This function can be used for connecting PLC, Remote I/O data acquisition module, Smart meter, Power monitoring moduel, Smart transducer, Diesel generator, Accumulator battery monitoring system...

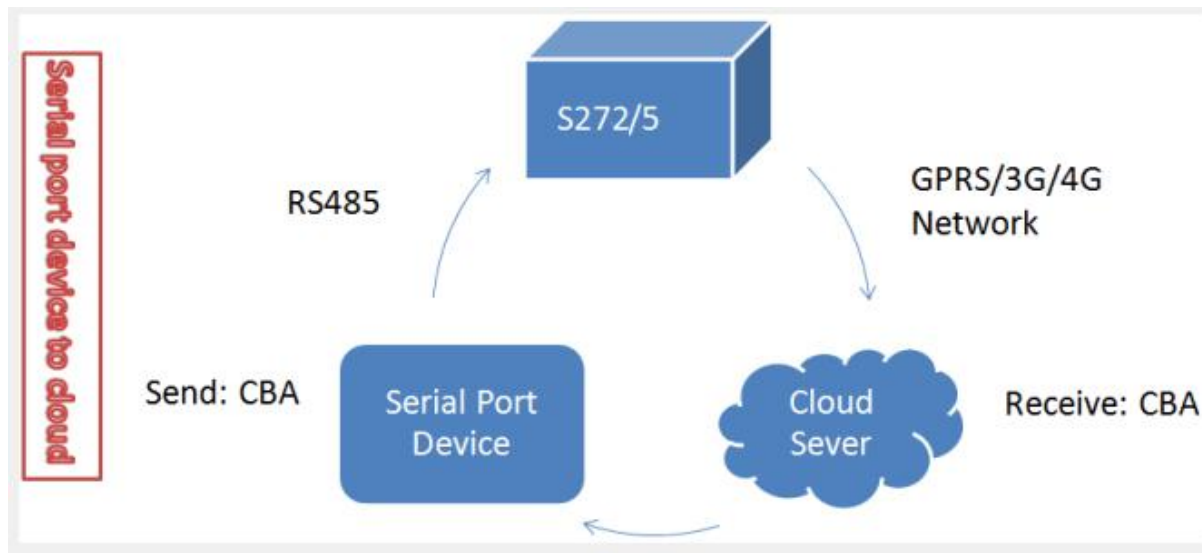
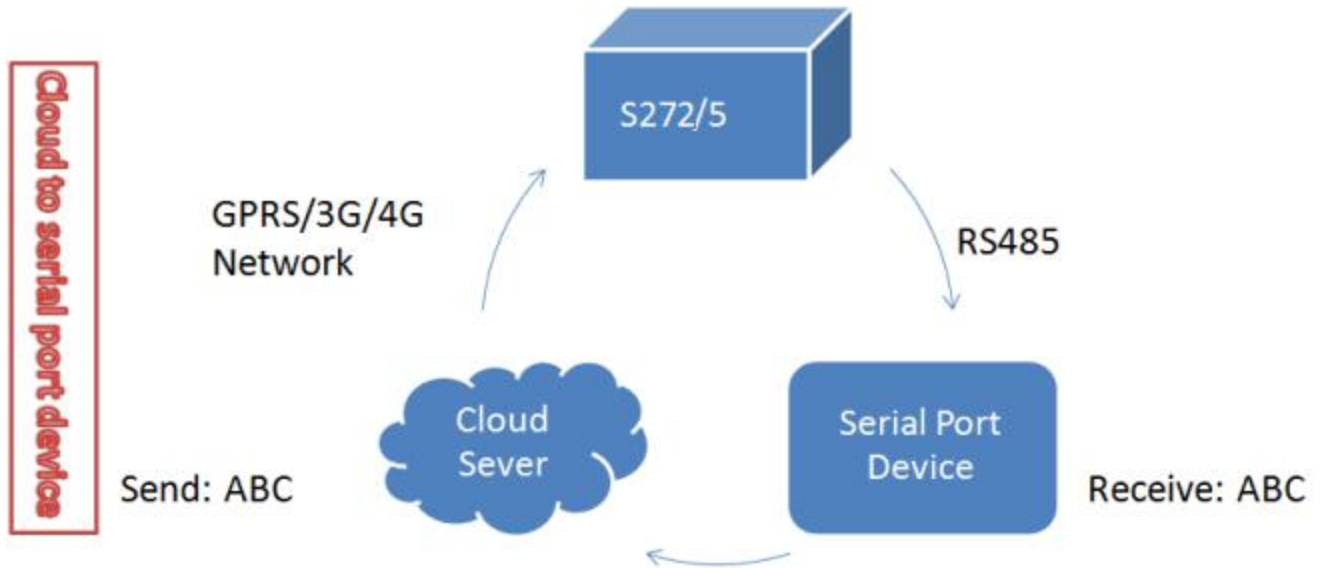

Modbus RTU Master function:

When RS485 as Modbus RTU Master, can extend I/O tags, support max 16 slaves for connecting PLC, Remote I/O data acquisition module, Smart meter, Power monitoring moduel, Smart transducer, Diesel generator, UPS, Accumulator battery monitoring system...; Can mapping register value from Slave to Master, these registers' can be setup high or low threshold value, and NC/NO type, moreover, can enable to send SMS to users once alarm occurrence by the registers if required. Also can remote control Slaves by writing coil.

Mapping Register Table and function code:

Reminder:

1. Use this function code when connect to Modbus RTU/Modbus TCP upper computer via GPRS/3G/4G (Device as Modbus RTU Slave). Stands for when Cloud communication with S275, the S275 is Modbus RTU Slave of Cloud Server.
2. When device connect to Modbus RTU/Modbus TCP upper computer via GPRS/3G/4G (Device as Modbus



RTU Slave). The I/O of S275 itself refer to "Modbus RTU Slave function" above.

Boolean Slave Register Assignment Table

Holding Coil (Function Code 1, Function Code 5, Function Code 15.)		
Boolean Register Address (Decimal)	Definition	Description
64	Boolean 64	Boolean type, slave mapping address, can mapping slave input coil and holding coil status.
65	Boolean 65	Same as above
.....	125 data similar as above	Same as above
127	Boolean 127	Same as above

16 Bit Slave Register Assignment Table

Support 03/06/16 function code, 1 data take one address in Modbus protocol, total can mapping 128 slave data.

Read and Write Holding Register (Function Code 03,Function Code 06, Function Code 16)			
16 Bit Register Address (Decimal)	Definition	Data Type	Description
20000	16 Bit data 20000	Sort AB, its data type according to slave mapping data type	According to configuration set mapping rules, this address will sort slave mapping data to AB, stock in this address, for cloud easy reading together, can mapping slave inputting and holding register.
20001	16 Bit data 20001	Same as above	Same as above
20002	16 Bit data 20002	Same as above	Same as above
.....	124 data similar as above	Same as above	Same as above
20127	16 Bit data 20127	Same as above	Same as above

Slave Mapping Register Range	Model No.	S272 (Decimal)
Boolean mapping address		64-127
16 Bit data mapping address		20000-20063
32 Bit data mapping address		None
64 Bit data mapping address		None

Adding Slave (Mapping address or Modbus RTU converter to SMS alarm gate way)

When RS485 as Modbus RTU Master, can read mapping registers, support max 16 slaves for connecting PLC, Remote I/O data acquisition module, Smart meter, UPS, Power monitoring...

When RS485 as Modbus RTU Master, the device will polling the slaves, read the slave register value to device mapping address and stock them as below. The yellow part is mapping register area.

Slave Mapping list:

This page is for adding, revising and deleting the slaves. Pls read the slaves mapping list first before **right click** blank part to add slave.

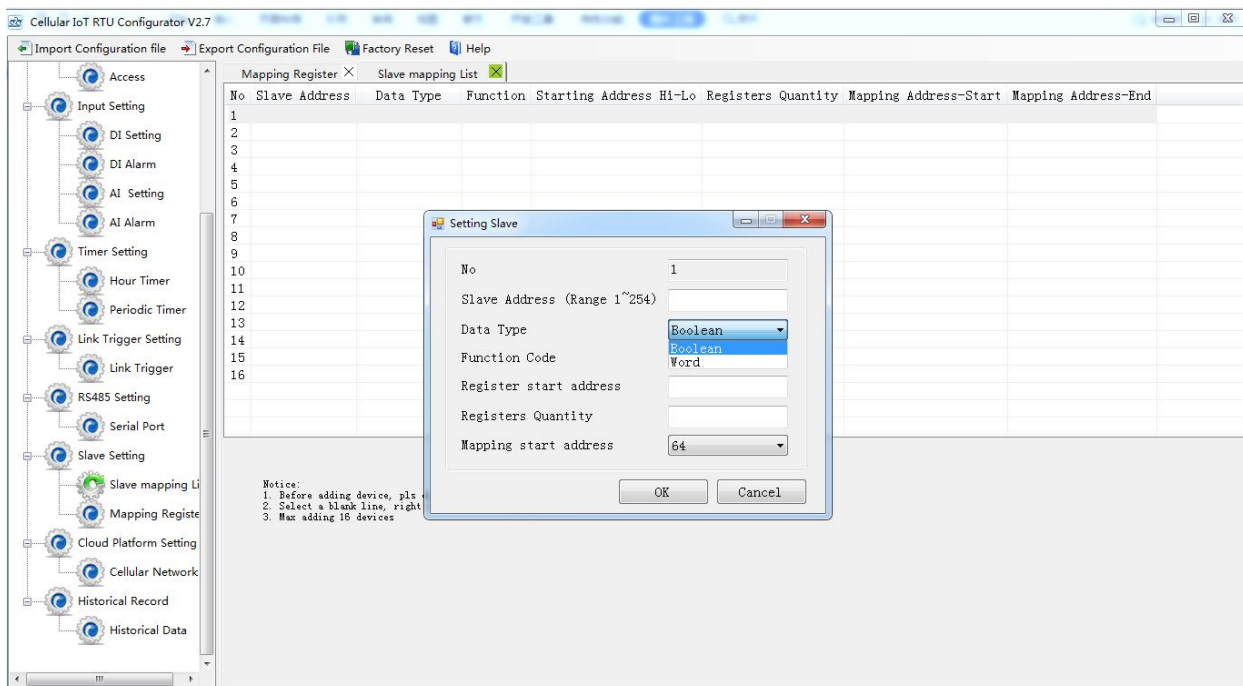

Slave Address: Stands for the Modbus RTU Slave ID.

Data Type: Stand for "Boolean", "16 Bit", "32 Bit", "64 Bit".

Function Code: Stand for Modbus RTU protocol function code, command for slave reading and writing.

Register Start Address: The starting register address for slave data reading and writing.

Registers Quantity: How many data quantity need to read, used for mapping to device register address.

Mapping Address-Start: Stand for mapping the slave start register data to the device start mapping address.

Mapping Address-End: Calculate the end mapping address according to start address and reading data quantity.

The example of Mapping Register as below:

Mxxx remote I/O module, slave register start address is 100, reading data qty is 3, the device(S272/5) mapping register start address is 1; Smart meter slave register start address is 6, read data qty is 4, the device mapping register start address is 4.

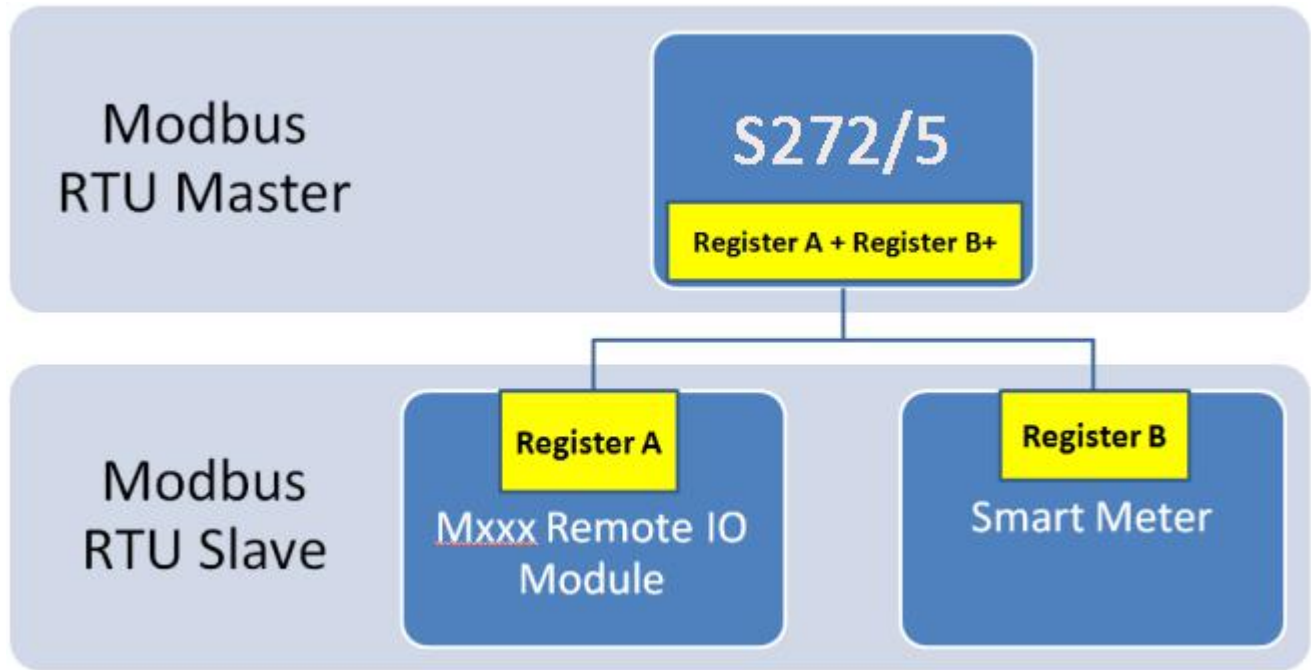

If so, when reading/writing device register 1~3, actually is reading/writing 100, 101, 102 register of Mxxx remote I/O module; When reading/writing device register 4~7, actually is reading/writing 6~9 register of smart meter

Slave Setting(Add slave&slave alarms):

- Step1:** Connect the slave to device(S272/5) RS485 port.
- Step2:** Find the slave port communication parameter and register address from user manual.
- Step3:** Write device RS485 parameter according to slave port communication parameter, pls ensure both parameter are same, others communication failure, refer to "port setting" part.
- Step4:** Set RS485 port as Modbus RTU Master, then set polling and time out parameter, refer to "port setting" part.
- Step5:** Back to Slave Mapping page as below, right click the line to add.

Click Add Slave as below:

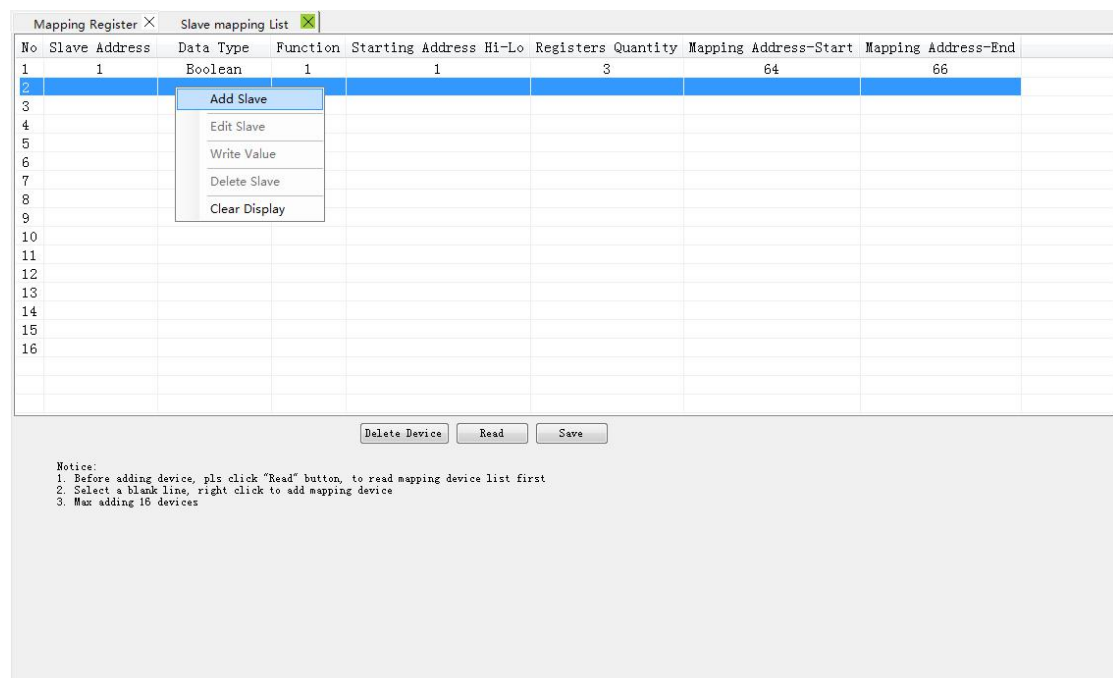

No	Slave Address	Data Type	Function	Starting Address	Hi-Lo	Registers Quantity	Mapping Address-Start	Mapping Address-End
1	1	Boolean	1	1	3	64	66	
2								
3								
4								
5								
6								
7								
8								
9								
10								
11								
12								
13								
14								
15								
16								

Notices:
 1. Before adding device, pls click "Read" button, to read mapping device list first
 2. Select a blank line, right click to add mapping device
 3. Max adding 16 devices



If one slave have multi register, then need to add separately according to register type; For example, Mxxx remote I/O module, with digital and analog inputs, need to add the digital(Boolean) first, then add the analog(16 Bit).

Step6: Right click the line to edit the slave.

No	Slave Address	Data Type	Function	Starting Address Hi-Lo	Registers Quantity	Mapping Address-Start	Mapping Address-End
1	1	Boolean	1	1	3	64	66
2							
3							
4							
5							
6							
7							
8							
9							
10							
11							
12							
13							
14							
15							
16							

- Add Slave
- Edit Slave**
- Write Value
- Delete Slave
- Clear Display

Click the "Edit Slave" to list the register according to chosen type (Boolean, 16 Bit **only**). Boolean list edit as below:

Address Mapping	Channel Name	Data Type	Input Type	Alarm Verify Time	Alarm SMS Content	Recovery SMS Content	Enable Recovery	Enable SMS	Relay0	Relay1	Relay2	Relay3	Enable
64	Tag64	DATA_BOOL	NO	2			<input type="checkbox"/>	<input type="checkbox"/>	<input type="checkbox"/>	<input type="checkbox"/>	<input type="checkbox"/>	<input type="checkbox"/>	<input type="checkbox"/>
65	Tag65	DATA_BOOL	NO	2			<input type="checkbox"/>	<input type="checkbox"/>	<input type="checkbox"/>	<input type="checkbox"/>	<input type="checkbox"/>	<input type="checkbox"/>	<input type="checkbox"/>
66	Tag66	DATA_BOOL	NO	2			<input type="checkbox"/>	<input type="checkbox"/>	<input type="checkbox"/>	<input type="checkbox"/>	<input type="checkbox"/>	<input type="checkbox"/>	<input type="checkbox"/>



Address Mapping	Channel Name	Data Type	Ratio	Alarm Verify Time	Shreshold high	Shreshold low	High Alarm SMS Content	Low Alarm SMS Content	Recovery SMS Content	Enable Recovery SMS	Relay0	Relay
	Tag64		1	2	0	0				<input type="checkbox"/>	<input type="checkbox"/>	<input type="checkbox"/>
	Tag65		1	2	0	0				<input type="checkbox"/>	<input type="checkbox"/>	<input type="checkbox"/>
	Tag66		1	2	0	0				<input type="checkbox"/>	<input type="checkbox"/>	<input type="checkbox"/>
20000	Int20000	DATA_SIGNED_AB	1	2	0	0				<input type="checkbox"/>	<input type="checkbox"/>	<input type="checkbox"/>

Address Mapping: Used for device to mapping slave register address.

Channel Name: Setup channel name, alarm/recovery send "channel name + alarm content" to authorize number, need to tick Slave Alarm function in number setting page.

Data Type: Fixed, already chosen when add slave.

Ratio: Real value=read register value*ratio.alarm threshold high low value is read register value *ratio.But when GPRS/3G/4G acquisition data will not multiple the ratio.

Input Type: NO NC optional, default NO. Choose NO: Normal is NO, not alarm when read 0, alarm when read 1; Choose NC: Normal status is NC, not alarm when read 1, alarm when read 0.

Alarm Verify Time: Stands for unnormal value last time more than this value, will send alarm SMS to authorize number.

Alarm SMS Content: When alarm happen, send SMS "channel name + content" to authorize number.

Recovery SMS Content: When alarm recovery, send SMS "channel name + content" to authorize number.

Enable Recovery SMS: Tick it, then can send SMS to authorize number when recovery.

Relay X: X=0~3, unnormal value will alarm-link relative relay.

Enable: Tick it stand for enable alarm function.

Reminder:

1.If need SMS Alarm function, pls tick Slave Alarm function for authorize number in Number Settings page.

2. When 16 Bit used for extend AIN inputs, can't converter acquisition ADC value to actual one according to range. For example: When Mxxx remote I/O module extend AIN, since Mxxx AIN register value is ADC, then device(S272/5) read value is also ADC value. But DAM122 AIN value is calculated to actual value according to range, then stored in register, so the value device read, is also calculated value.

When add slave, function code chosen 16, then write value page as below:

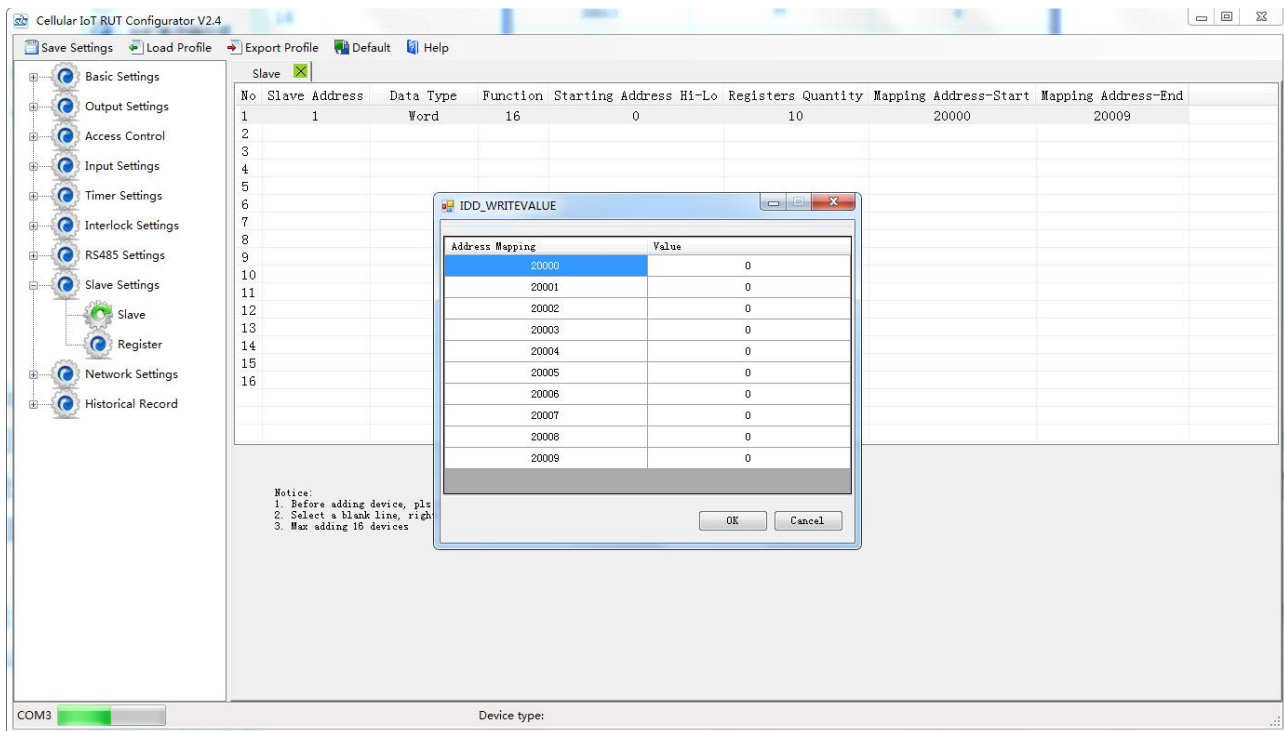
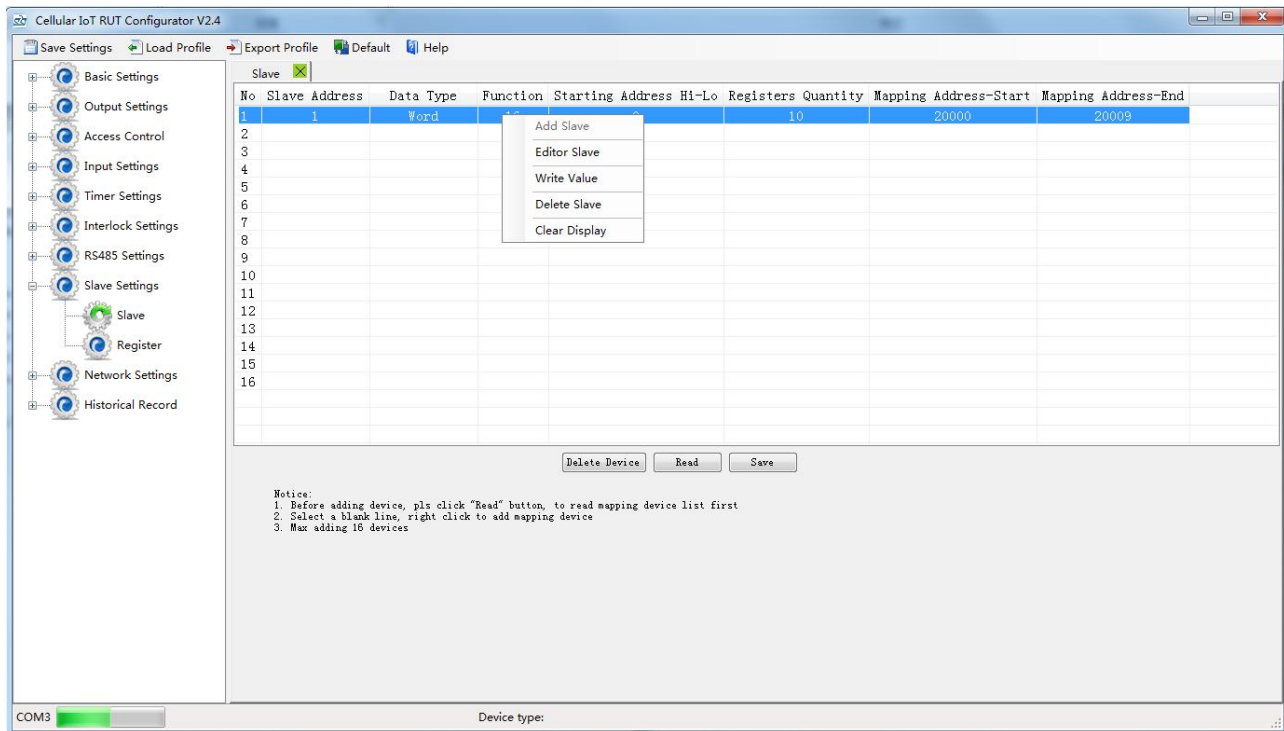

Revise value, click OK, will write the value to slave corresponding register

And can mapping the register to device, read its function code for slave data current status, to check if set successfully or not.

Step7: Click "Save" when operate finished, then click "Save Setting" in the menu, to save parameter to device.

Delete Slave:

Right click the slave which need to delete---->click the "Delete Slave"----> click "Save"---->click the "Save



Settings" in the menu as below:

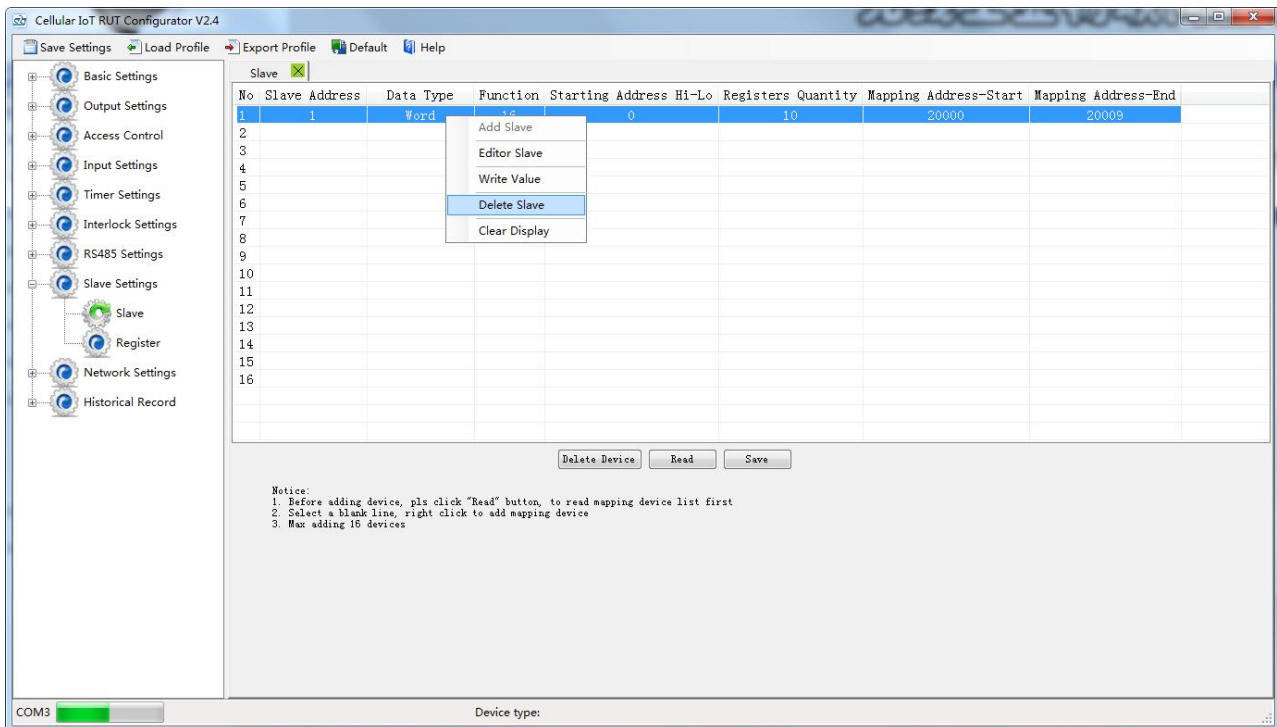

Query Slave Current Value:

Click "Register" page to real time check slave current value.

Reminder:

Before reading data, pls read slave list from "Slave Mapping List" first, then can check slave current value in "Register" page:

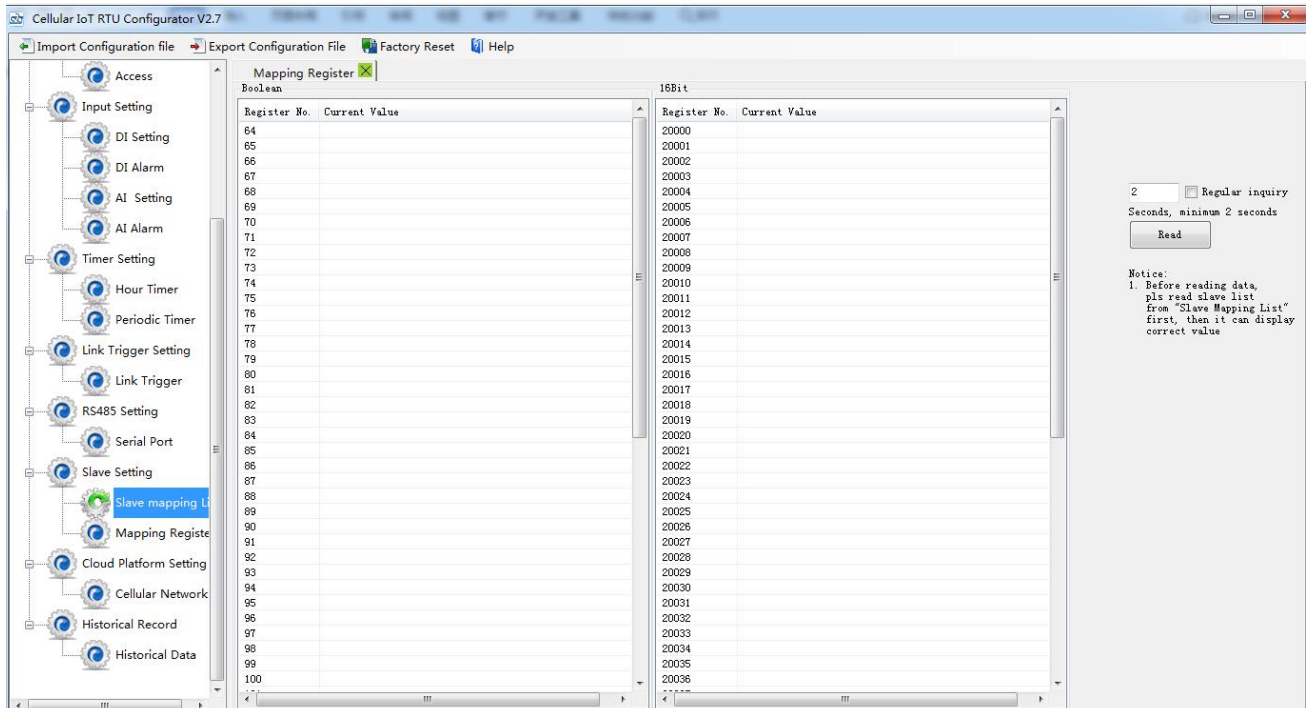

Network Settings



This page used for setting device parameters connect to networks. The device can compatible with many third party upper computer system. And it can communication with monitoring software or cloud via GPRS/3G/4G as below:

- 1) Modbus RTU Protocol, means Modbus RTU over TCP, communication with upper computer system. For example, connect to www.kpiiot.com cloud server. Domain: modbusrtu.kprtu.com, Port: 4000.
- 2) Modbus TCP Protocol, communication with upper computer system. For example, connect to www.my-m2m.com cloud server. Domain: modbus.dtuip.com, Port: 6655.
- 3) MQTT Protocol, connect to www.my-m2m.com cloud server. Domain: modbus.dtuip.com, Port: 6655.

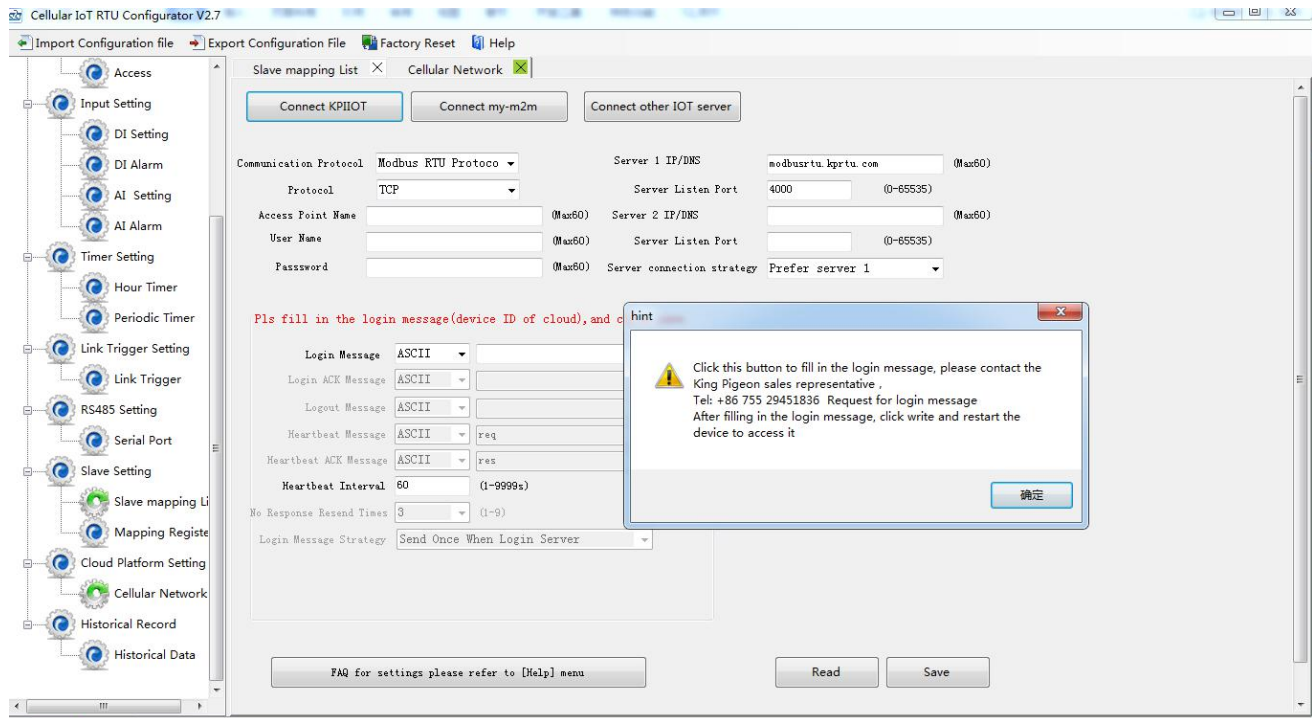

Note: If connect to KPIIOT or my-m2m cloud, only need ask King Pigeon sales for log in message, other part no need fill, keep as default.

Communication Protocol: "Disable", "Modbus RTU protocol", "IoT RTU protocol" or "Modbus TCP protocol" "MQTT" optional.

Protocol: TCP or UDP optional.

Access Point Name: APN, cellular operator provide.

User Name: User Name, operator provide.

Password: Network password, operator provide.

Sever 1/2 IP/DNS: Server IP address or DNS.

Listen Port: Stands for the server's listen port.

Server Connection Strategy: Only support "Prefer server 1" function, no "Both connection" now. When server 1 disconnect, will connect to server 2 automatically.

Login Message: Server register handshake protocol package. When transparent transmission or Modbus protocol, this item used for device ID, provided by cloud. Contact King Pigeon sales if need to connect www.kpiiot.com cloud server.

Login ACK Message: Once set, device need response within 10 seconds after device send login message, otherwise it will continue send login message according to "Reconnection Times", still not response will offline once time, then try to reconnect, according to "Server Offline 3 Times, Device Reconnection Time".

Logout Message: Once server send to device, device will be offline.

Heartbeat Message: Heartbeat content to avoid network offline.

Heartbeat ACK Message: Once set, device need response within 6 seconds after device send heartbeat message, otherwise it will continue send login message according to "Reconnection Times", still not response will offline once time, then try to reconnect, according to "Server Offline 3 Times, Device Reconnection Time".

Heartbeat Interval: Network keep online heartbeat interval time.

No Response Resend Times: After setting heartbeat and login message, if server no response, the times which server will send data.

Login Message Strategy: "Send Once When Login Server", "Plus It In Front Of Every Packet", "Both Of Them" optional. "Plus It In Front Of Every Packet" when data transmission.

Historical Record

The device inbuilt 8G SD card, store alarm and historical records. For saving historical records, need to set the saving historical records interval time in "Periodically Timer" page.

For historical record, once it full, will automatically remove the earlier records for new records. And can save as CS format for other purpose usage.

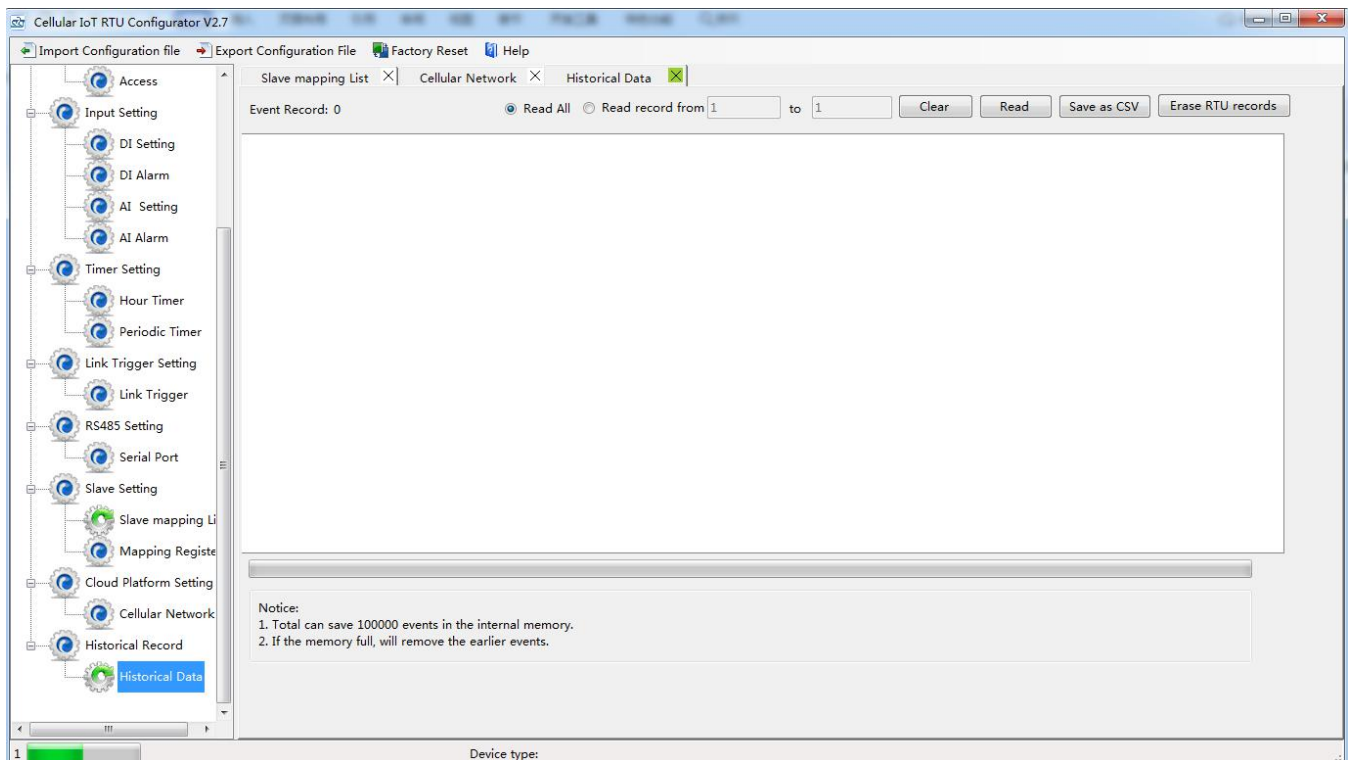

Total: Display device current historical records qty, "Read All" or "Read Record from xx to xx" optional.

Clear: Clear the screen.

Read: Read historical records.

Save as CSV: Historical records export as CSV file.

Erase RTU Records: Click this button will erase all device historical records, be careful.

7. Example Of Applications

Device working self-checking:

(1) Under setting mode, switch Dip to "Set"---->Switch device on---->Running configurator, choose port and password enter into software basic parameter settings---->Click "Read the computer time"---->Then click "Write the RTU time" for device time setting. At the same time, tick "v" for "Arm automatically when power on", then click "Save" button as below:

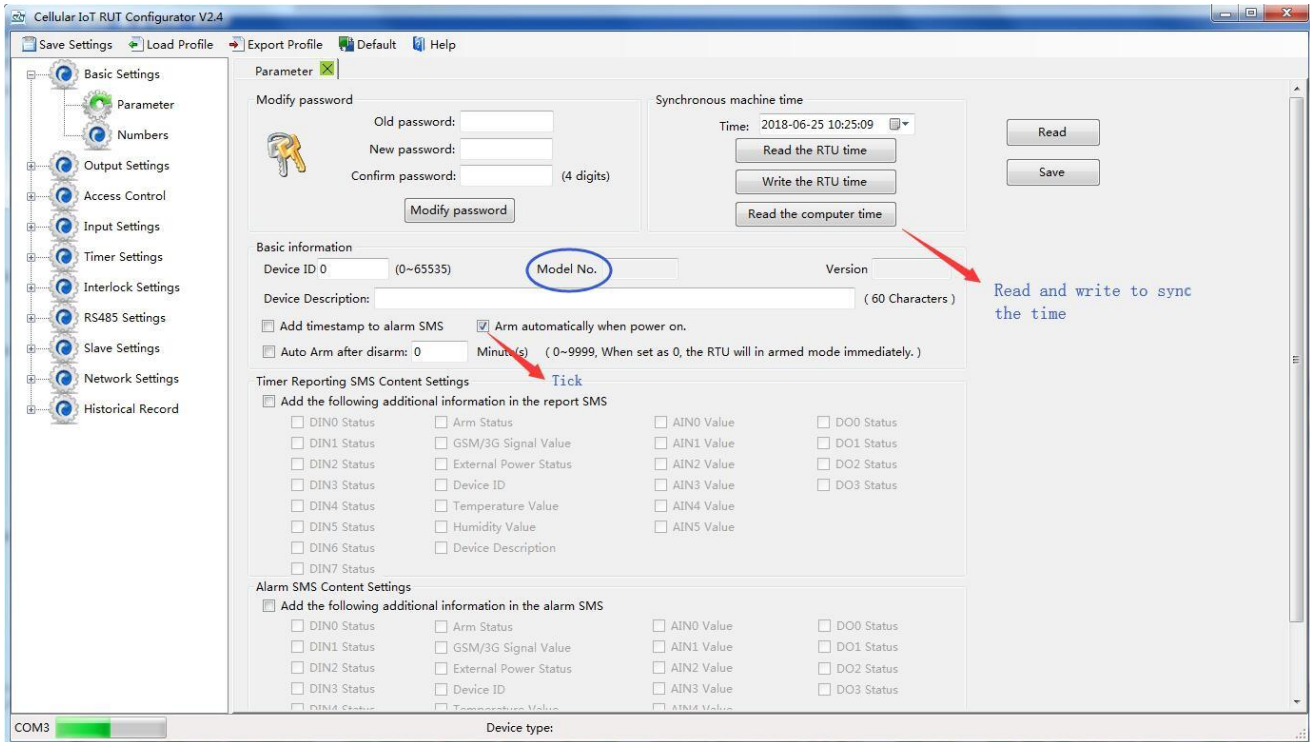

(2) Under "Number Settings" page, write authorize number and tick the times needed. For example, if need power on, external power off/recovery SMS, then tick and write as below:

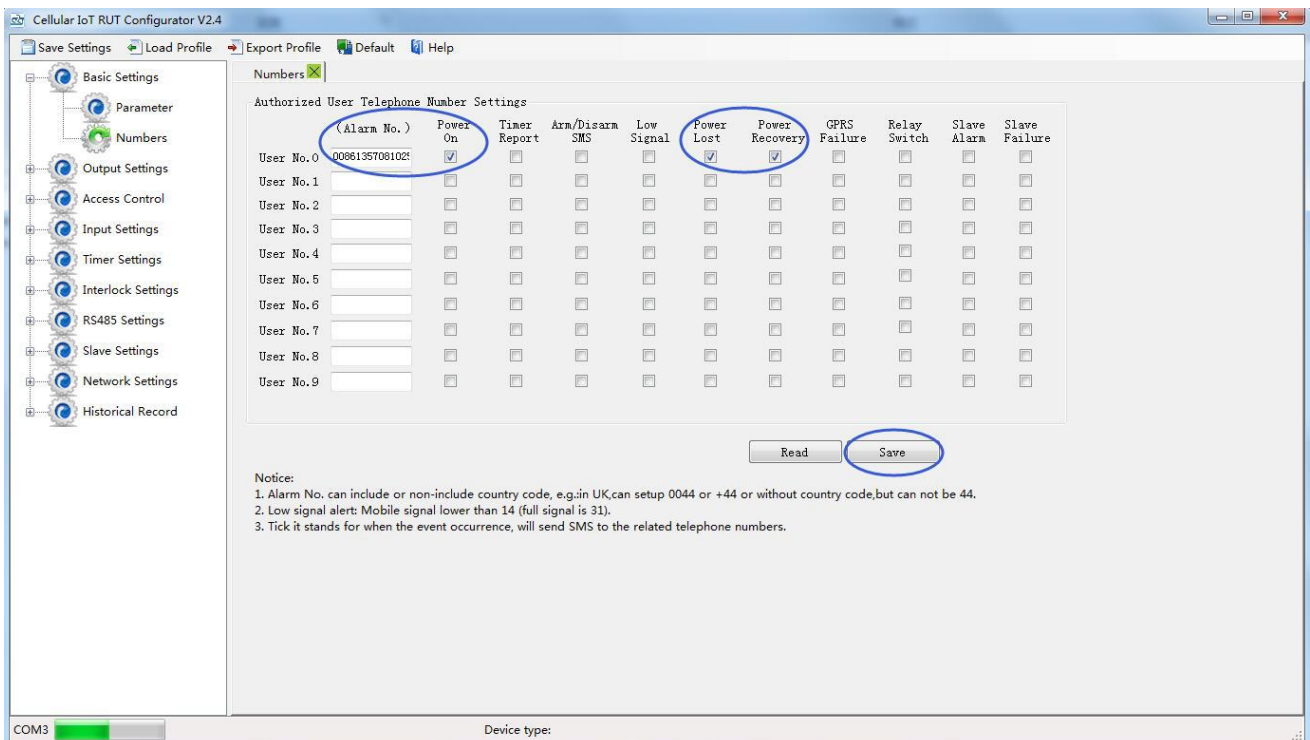

(3) Click "Save Settings"---->Switch device off---->Switch working mode to "Run"---->Put it SIM card and switch device on. 1~2 min after SIM card register network, power on SMS should be received---->The cut the external power, the power lost SMS should be received---->Connect the power support to device again, then power recovery SMS should be received. Thus, the device communication self-checking finished.



Device connect analog transducer:

If AIN0 need to connect a temperature transducer, transducer output 4~20mA signal, measurement range: -40~100°C, when temperature last 2 seconds higher than 35°C need to alarm, last 2 seconds lower than 20°C also need a alarm, then set as below:

Mode	Analog Input Type					
	0	1	2	3	4	5
Set	V	V	V	V	V	V
Run	mA	mA	mA	mA	mA	mA

(1) Switch device off, then switch AIN0 input type to "mA";

(2) Wire connect temperature transducer to AIN0 input as below:

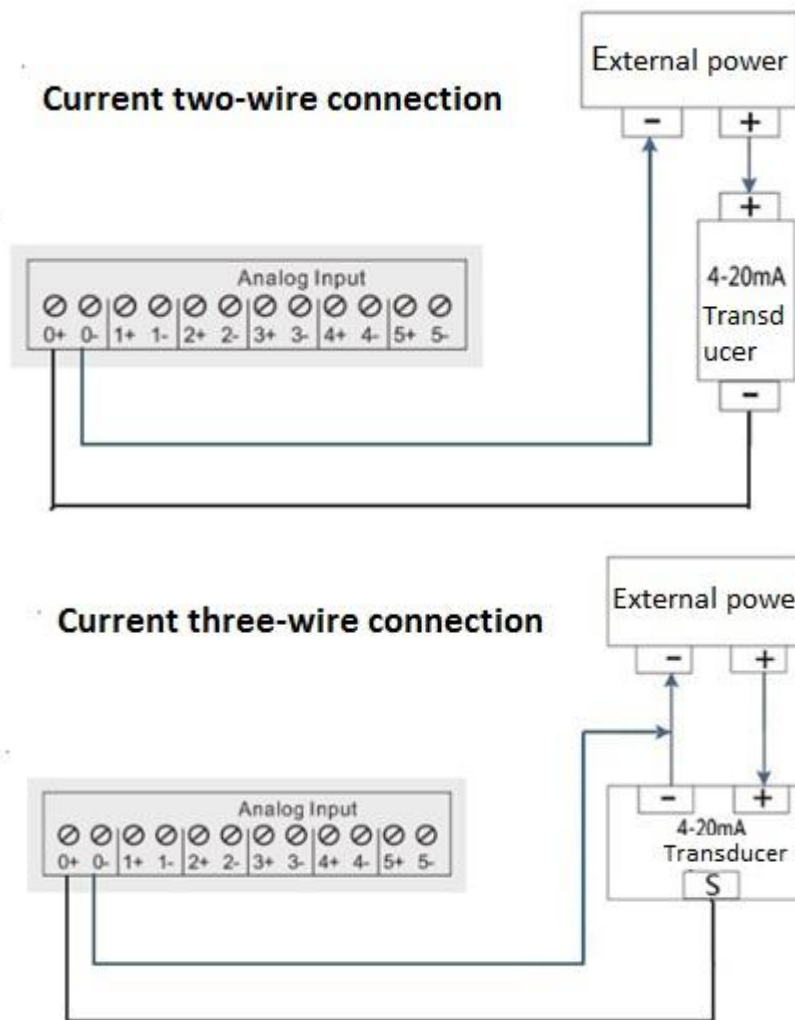

(3) Basic setting according (1) and (2) in "Device working self-checking";

(4) Enter into "AIN Trigger" page---->Set input type to "4~20mA"---->Write "High/Low Alarm SMS"---->"Maximum": 100, "Miximum": -40, "Threshold High": 35, "Threshold Low": 20, "Verify Time": 2. If still need recovery alarm SMS, then need to tick "Recovery Alarm", and write content in "Recovery SMS"---->After that, click "Save" as below:

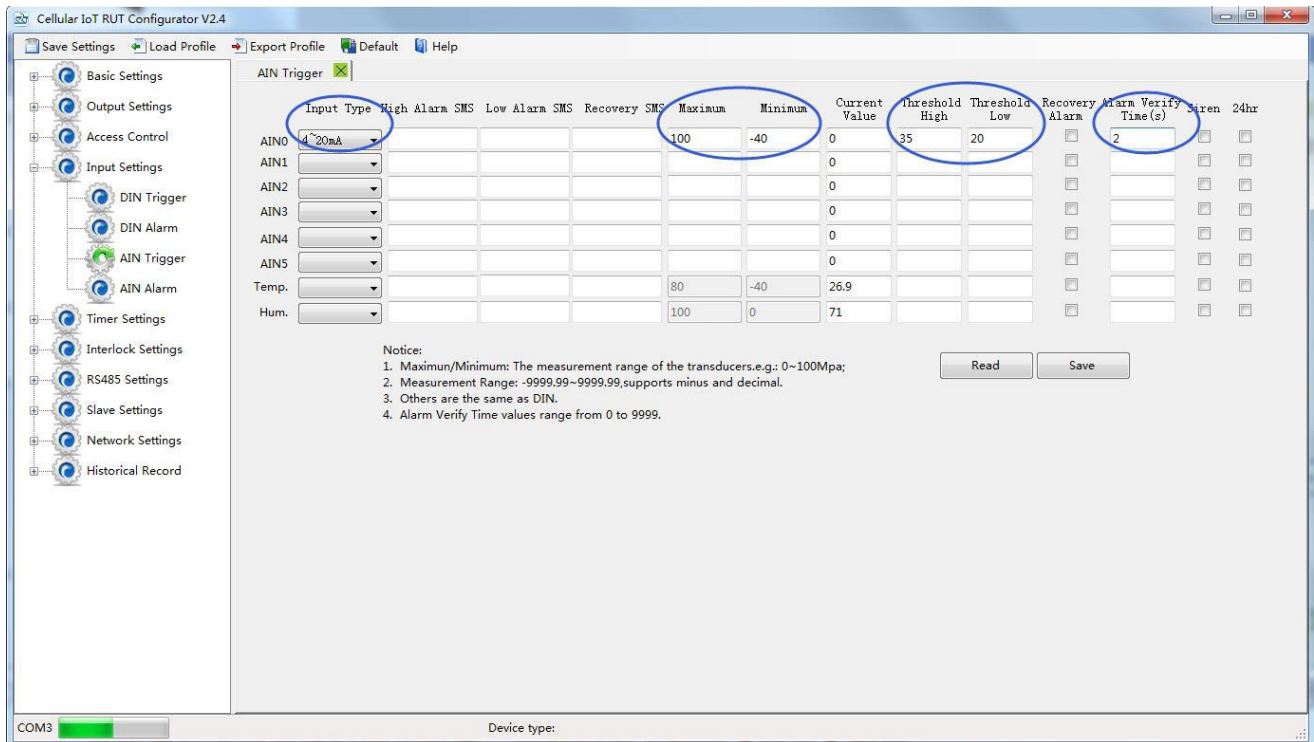

(5) In "AIN Alarm" page, tick the corresponding items for authorize number. For example, when AIN0 alarm, will can and send SMS to authorize number "0", remember to click "Save" as below:

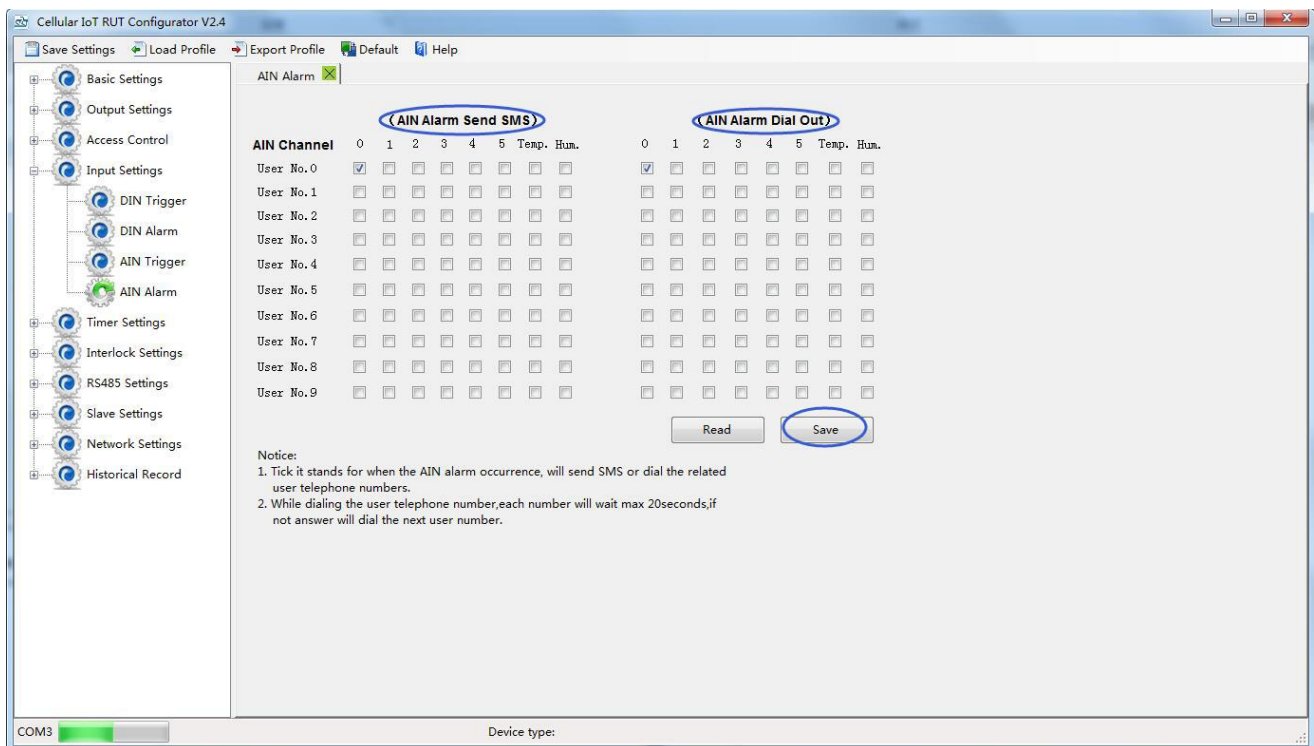

(6) Click "Save Settings" in the menu, then switch device off;

(7) Switch DIP mode to "Run", working mode as below:

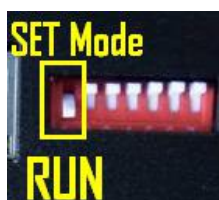

(8) Switch the device on, then device enter into working mode.

Application:

When monitoring cabinet temperature, if higher than 38°C, need to start the cabinet fan; If lower than 25°C, need to close the fan.

Need: Temperature/Humidity transducer AM2301 and 1 channel relay output, if choose the first relay DO0, the set as below:

(1) Switch device off---->connect temperature/humidity transducer to T/H port---->connect the cabinet fan to DO0 output as below:

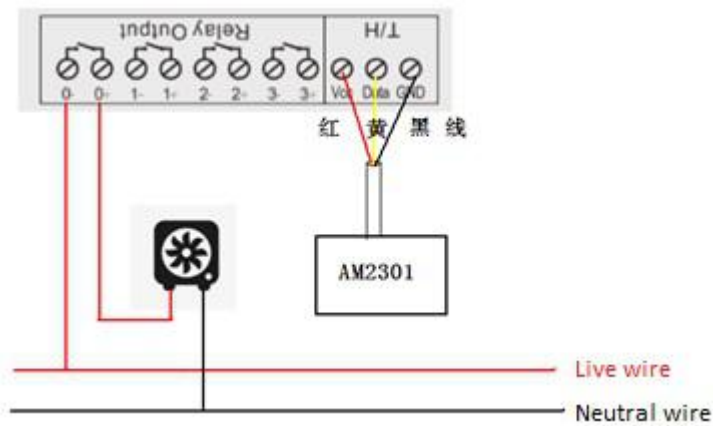

(2) Basic setting according (1) and (2) in "Device working self-checking";

(3) In "Output Settings" page, set first relay DOUT0, output type: Switch on/off, channel name: cabinet fan, close time: 0, 0 means always close. Click "Save" button as below:

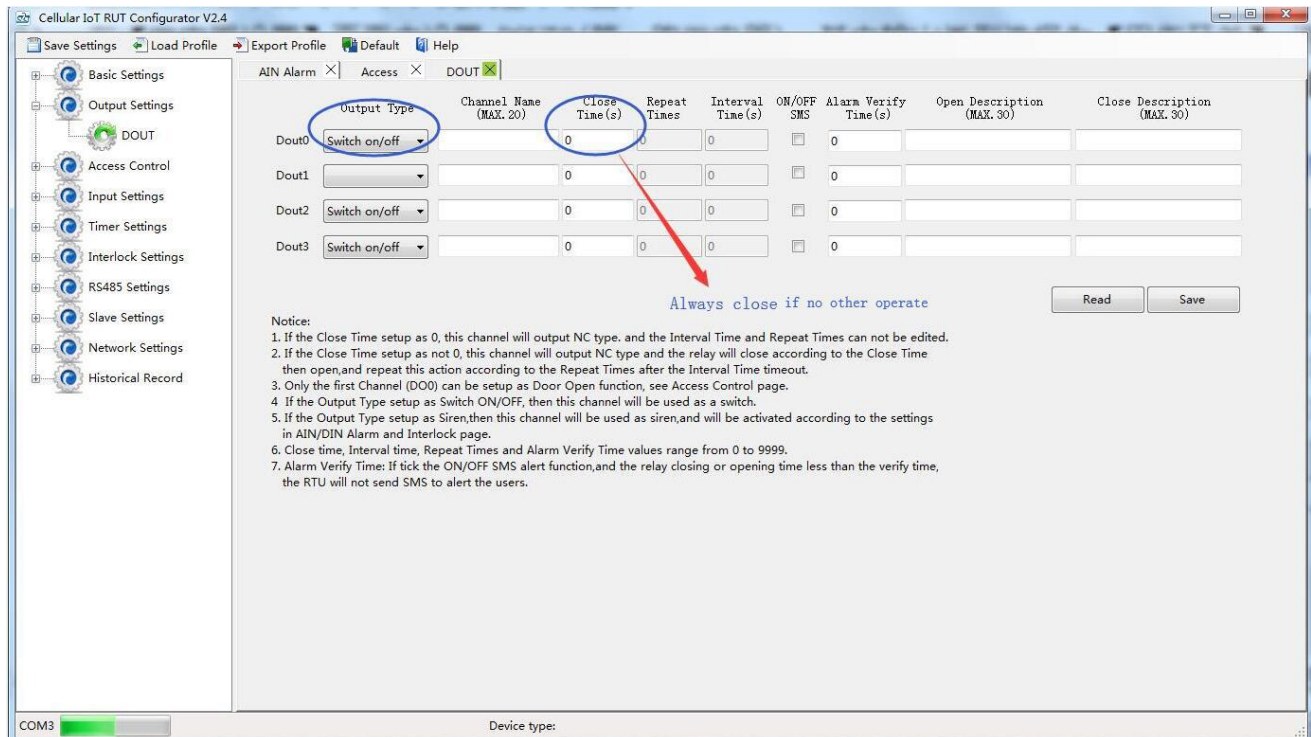

(4) In "AIN Trigger Setting" page, set temperature type "Enable"---->Humidity and AIN0~7 choose "Disable" if not use---->Set corresponding alarm SMS content---->Threshold high: 38 and Threshold low: 25---->Recovery

(8) Switch the device on, enter into working mode.

RS485 extend I/O tags and Modbus converter SMS alarm:

When RS485 as Modbus RTU Master, can extend I/O tags, support max 16 slaves for connecting PLC, Remote I/O data acquisition module, Smart meter, UPS, Power monitoring...

When RS485 as Modbus RTU Master, the device will poll the slaves, read the slave register value to device mapping address and stock them. Could server can read and control via GPRS/3G/4G networks according to King Pigeon RTU protocol, Modbus RTU over TCP or Modbus TCP protocol. Now remote I/O module M100 (2DI, 2DO, 2AI) as example:

Reminder:

The AIN data acquisition of Mxxx is ADC current or ADC voltage, device never calculated according to AIN max or min range. If need extend AIN to read calculated real value, pls choose the acquisition module with inside converter function, such as DAM:

Model List		
DAM114	2AIN	12 Bit resolution, default input 4~20mA
DAM116	4AIN	12 Bit resolution, default input 4~20mA
DAM118	2PT RTD	12 Bit resolution, default PT-100, 2/3 wire connection
DAM120	4PT RTD	12 Bit resolution, default PT-100, 2/3 wire connection
DAM122	2AI+2PT	Same as above
DAM124	4AI+4PT	Same as above

(1) When order M100, if need relay output, need to mark DO as relay when place order;

(2) According to M100 user manual, set port Baud Rate and device ID as below:

M100 port parameter: Baud Rate (9600), Byte Size (8), Stop Bit (1), Parity (Even), M100 device ID: 1.

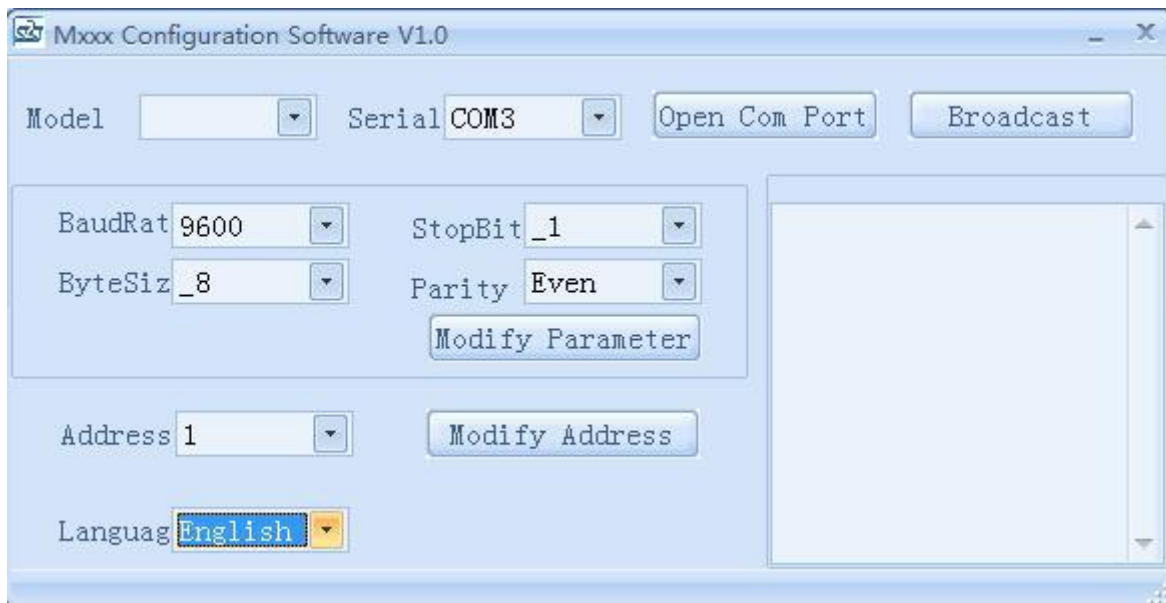

(3) Connect M100 to device, GND not necessary;

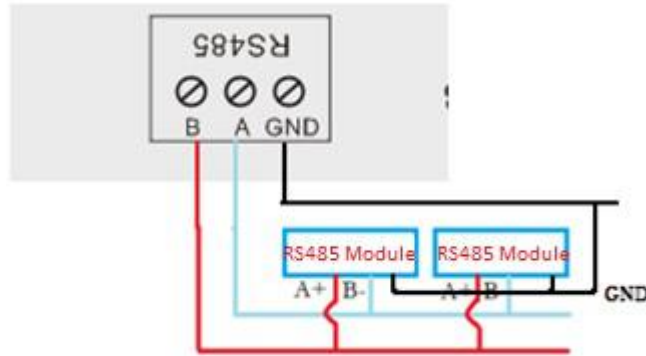

(4) Basic setting according (1) and (2) in "Device working self-checking";

(5) In "Serial Port" setting page, set device parameter as below:

A) RS485 choose as "Modbus RTU Master";

B) Baud Rate, Data Bit, Parity Bit, Stop Bit port parameter setting need to be corresponding with M100, otherwise not working; If one more slaves, all slave port parameter need to be corresponding with Master.

C) Scan Rate, Time out, Slave fault verify time can be according to default, if the slaves qty a little more, can set bigger value;

D) Click the "Save" button.

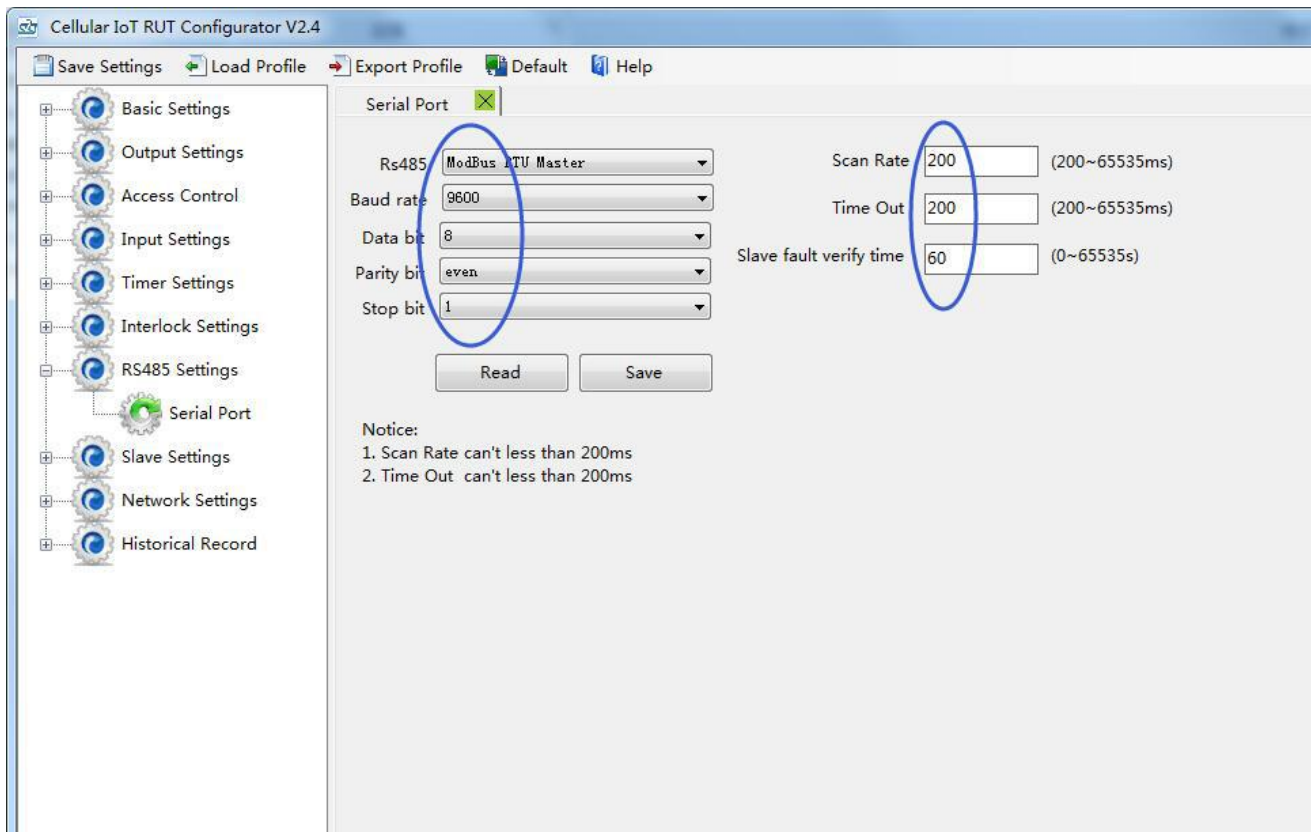

(6) In "Slave Mapping List" , right click a line---->Click "Add Slave". If have added slave information before, need to click "Read" first, to avoid other slave device information been covered.

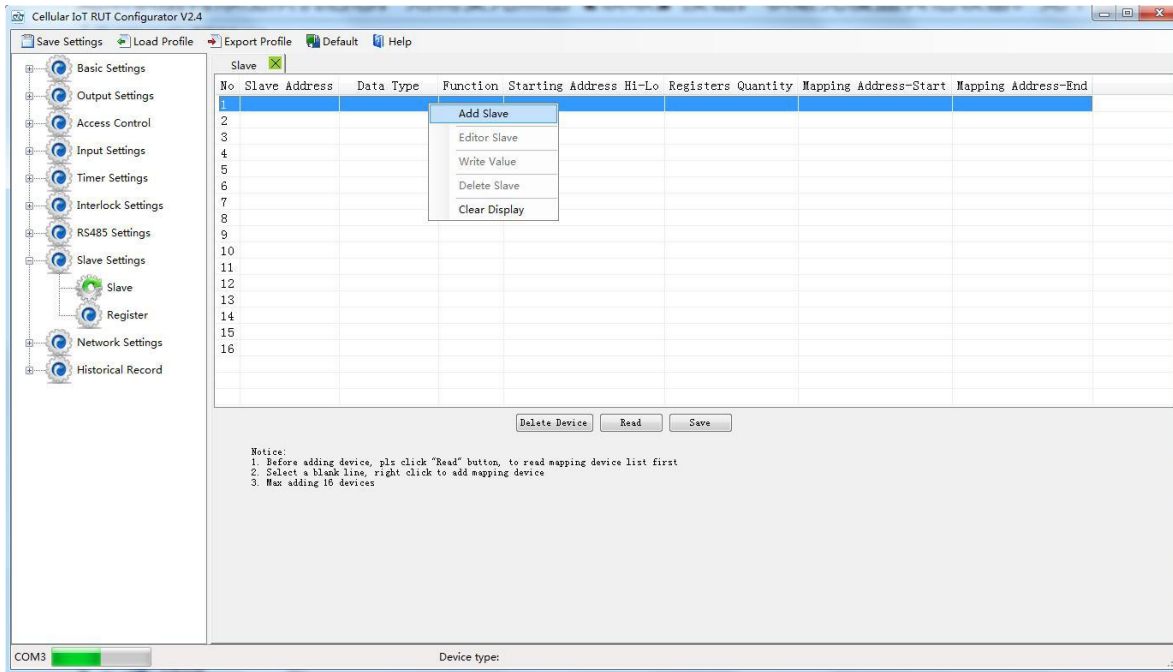

(7) Set slave M100 basic parameter, if one slave have multi input type and function code, need to set data type, function code and mapping register relationship separately as below:

A) Slave address: Refer to step (2), it is 1;

B) Set register mapping and function code:

⊕ According to M100 user manual, the DI data type and function code as below:

8.1 Read Input Coil (Function Code 2: Read Coil)

Read Input Coil (Function Code 2: Read Coil)			
Channel	Register Address	Data Type	Description
DIN 1	0	1Bit	DIN1 Value, Read Only,0=Open,1=Close.
DIN 2	1	1Bit	DIN2 Value, Read Only,0=Open,1=Close.

So the parameter set as below, the DI set to Boolean type, Function code 02, Register starting address 0, Register quantity 2.

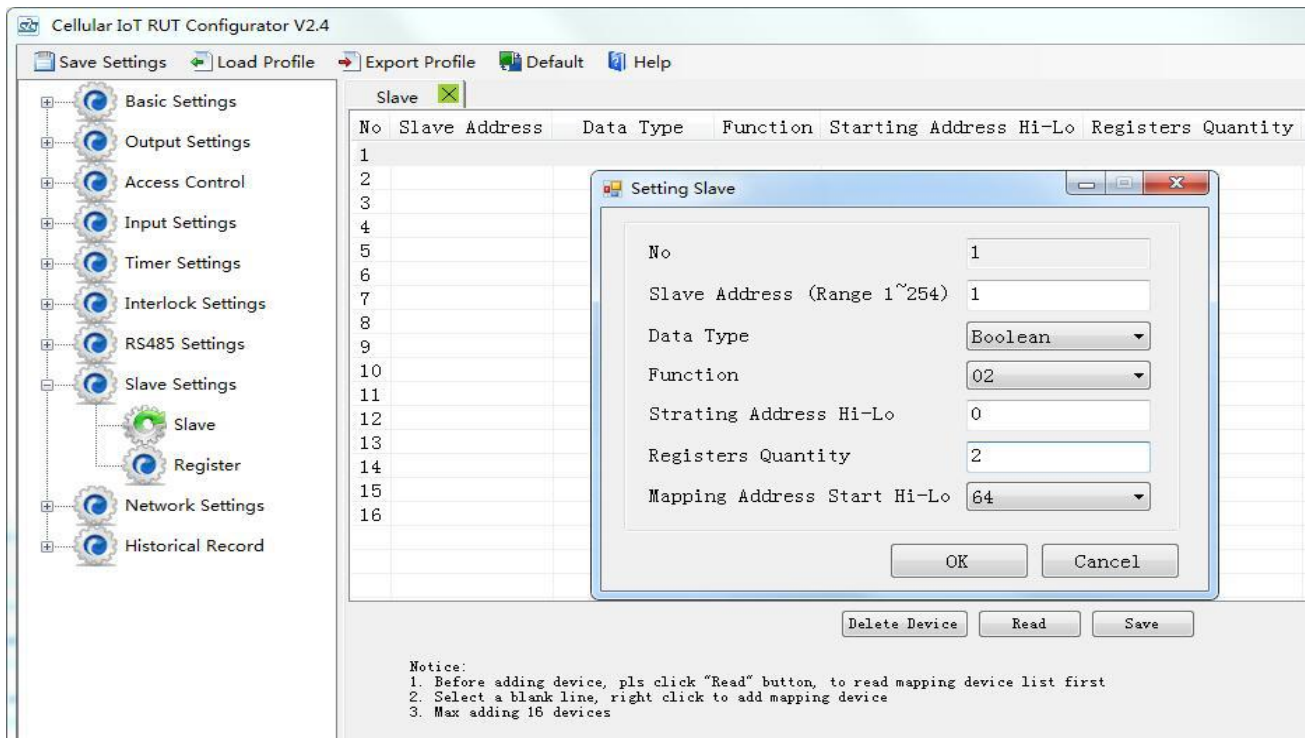

Click "Ok"---->Right click this line in "Slave" list---->Click "Edit Slave" as below:

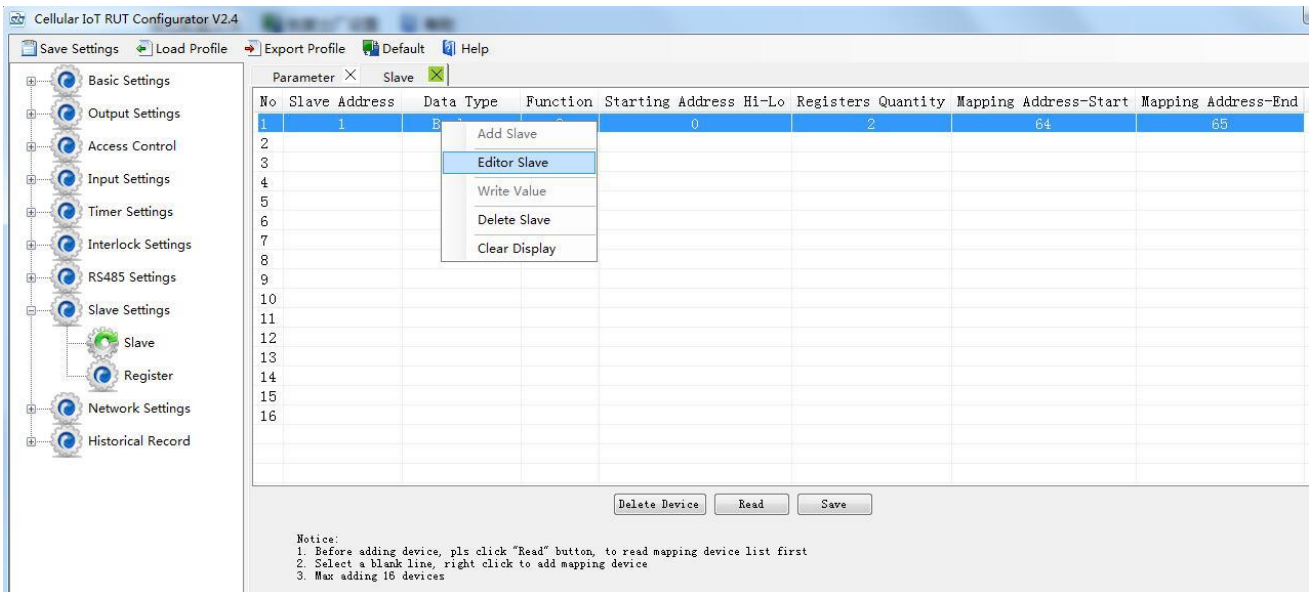

Then M100 DIN1 mapping address is 64, DIN2 mapping address is 65, DIN1 and DIN2 parameter can be editable. "v" Enable stands for enable this channel, "v" Relay 0 stands for when DIN1 trigger, DO0 will close. And "Alarm SMS Content", "Recovery SMS content" can be editable. After that, click "OK" as below:

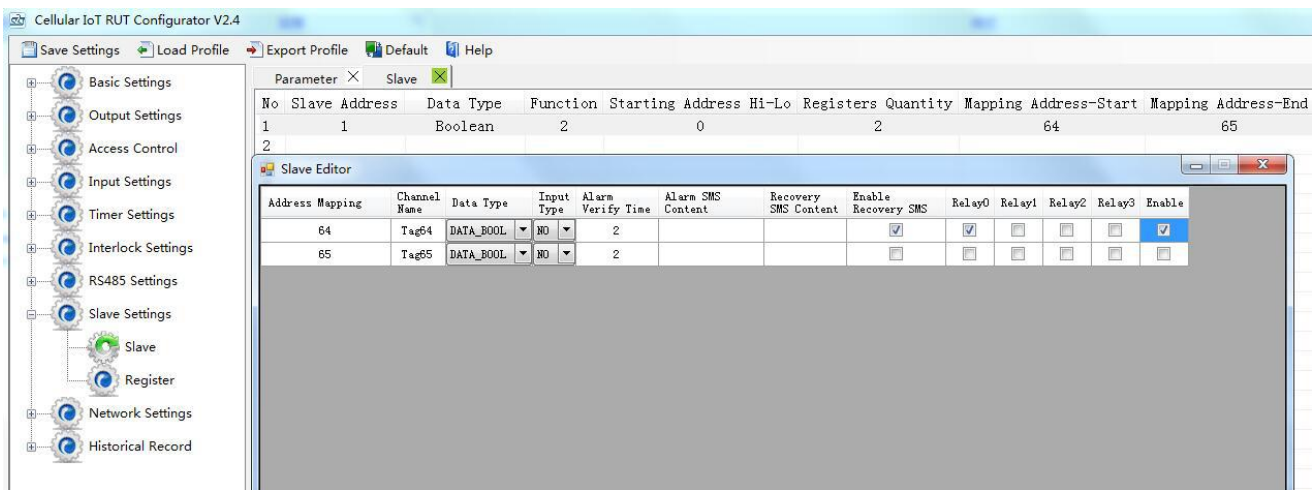

⊙ In "Slave Mapping List" page, right click blank line---->Choose "Add Slave"---->DO Data type and Function code as below according to M100 user manual.

8.2 Read and Write Holding Coil (Function Code 1: Read Coil, Function Code 5: Write Single Coil, Function Code 15: Write multi Coils.)

Read and Write Holding Coil (Function Code 1, Function Code, Function Code 15.)			
Channel	Register Address	Data Type	Description
DO 1	0	1Bit	DO1 Value, Read/Write, 0=Open,1=Close.
DO 2	1	1Bit	DO2 Value, Read/Write, 0=Open,1=Close.

So set DO parameter as below, set DO Data type to Boolean, Function code 1, Register start address 0, Register quantity 2.

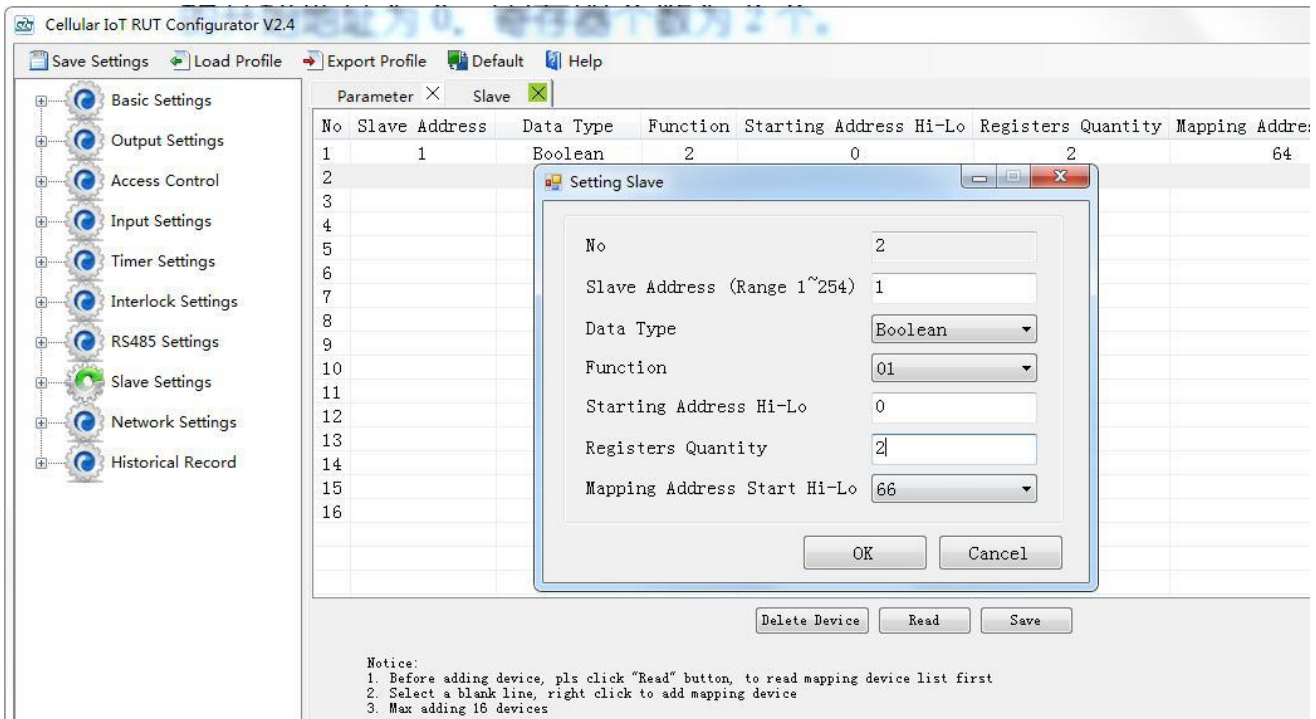

Click "OK"---->Right click this line in "Slave" list---->Click "Edit Slave" to edit the channel.

So set DO parameter as below, set DO Data type to Boolean, Function code 15, Register start address 1, Register quantity 2. Click "Add Slave" as below:

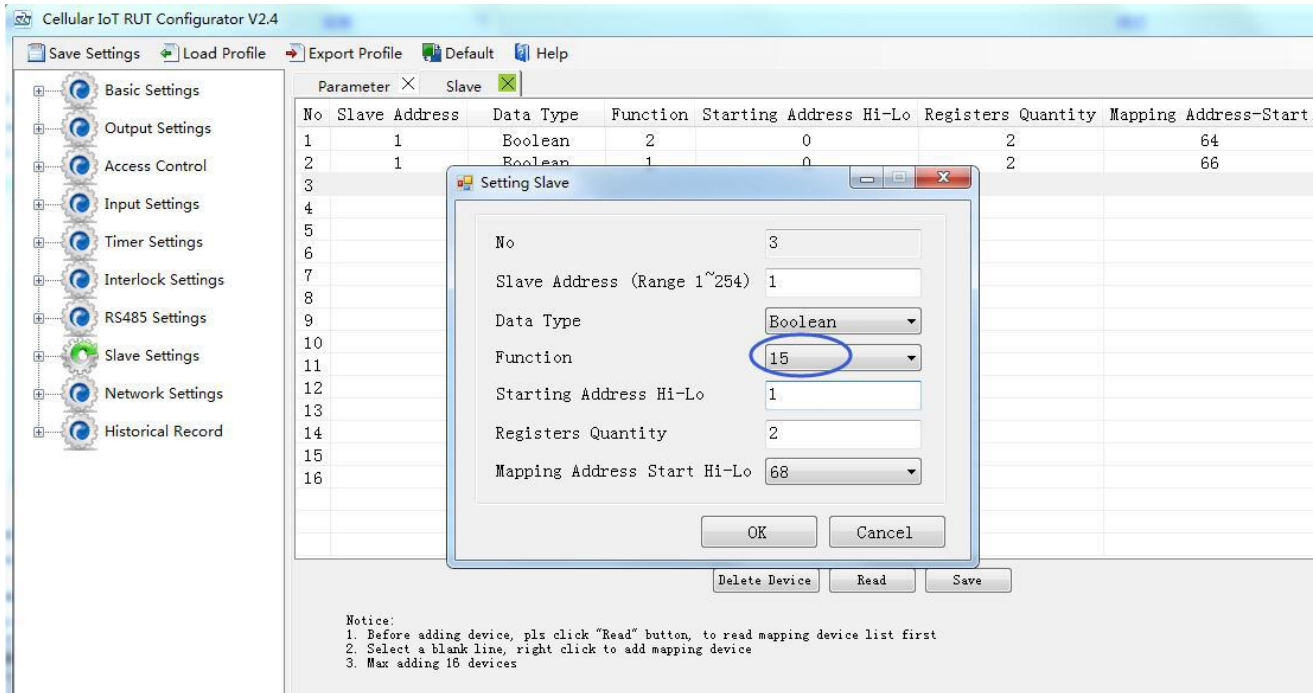

Click "OK"----> Right click this line in "Slave" list---->Click "Edit Slave" to edit the channel.

⊙ In "Slave Mapping List" page, right click blank line---->Choose "Add Slave". According to M100 user manual, AIN data is high byte in front, low byte behind, data type and function code as below:

8.3 Read Input Register (Function Code 4: Read Input Register.)

Read Input Register (Function Code 4: Read Input Register.)			
Channel	Register Address	Data Type	Description
AIN1/RTD 1	0	1 Word	AIN1/RTD1 Value, Read Only.
AIN2/RTD 2	1	1 Word	AIN2/RTD2 Value, Read Only.

So set AIN parameter as below, set AIN Data Type to 16 Bit, Function code 4, Register start address 0, Register quantity 2

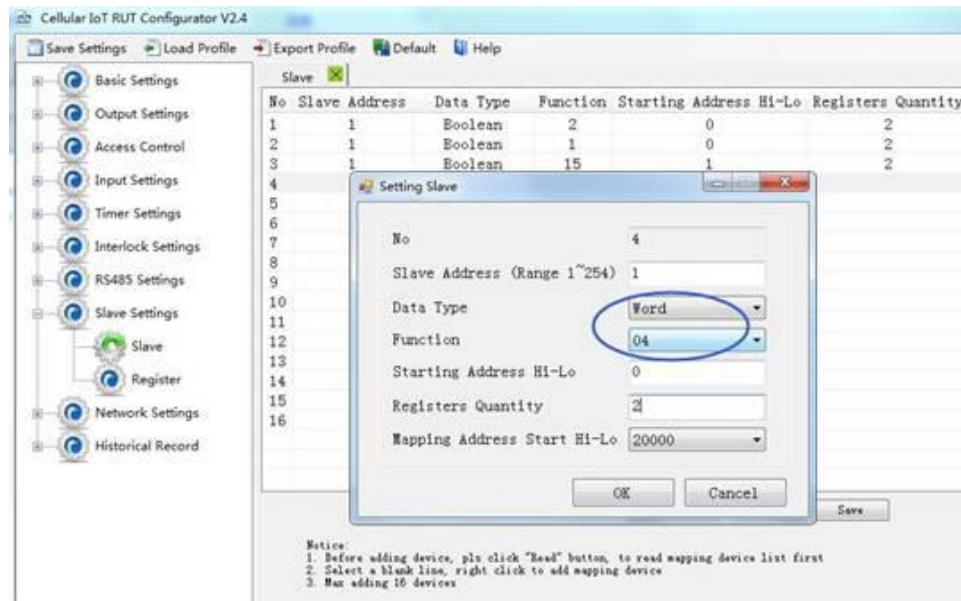

Click "OK"----> Right click this line in "Slave" list---->Click "Edit Slave" to edit the channel.

The M100 AIN data acquisition is ADC current or ADC voltage value, device have not calculated according to AIN max and min range. So the "Ratio" no need to write, both "Threshold High" and "Threshold Low" are ADC value.

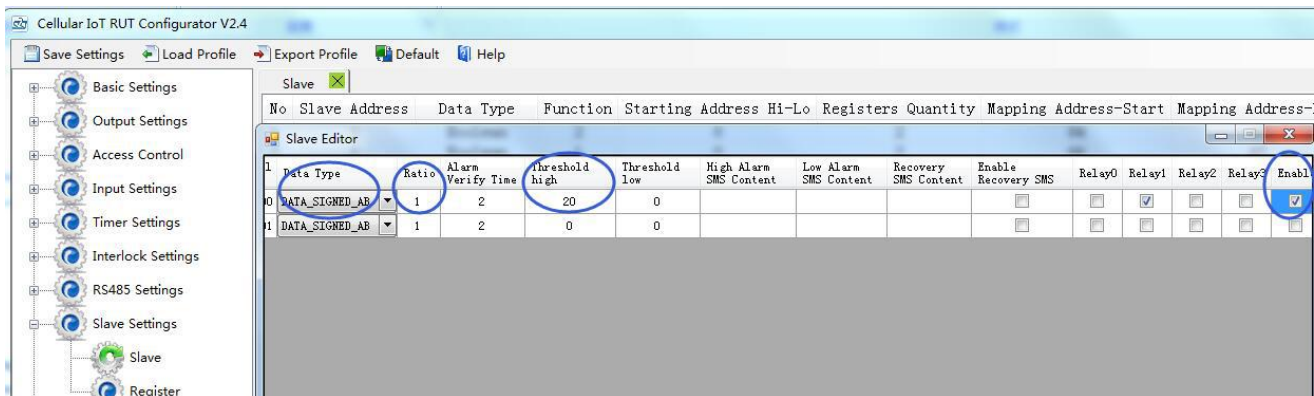

(8) Parameter setting finished, since slave address is from same one device, the Slaves address are same, Data type and Function code are not same. Click save button to write parameter into device.

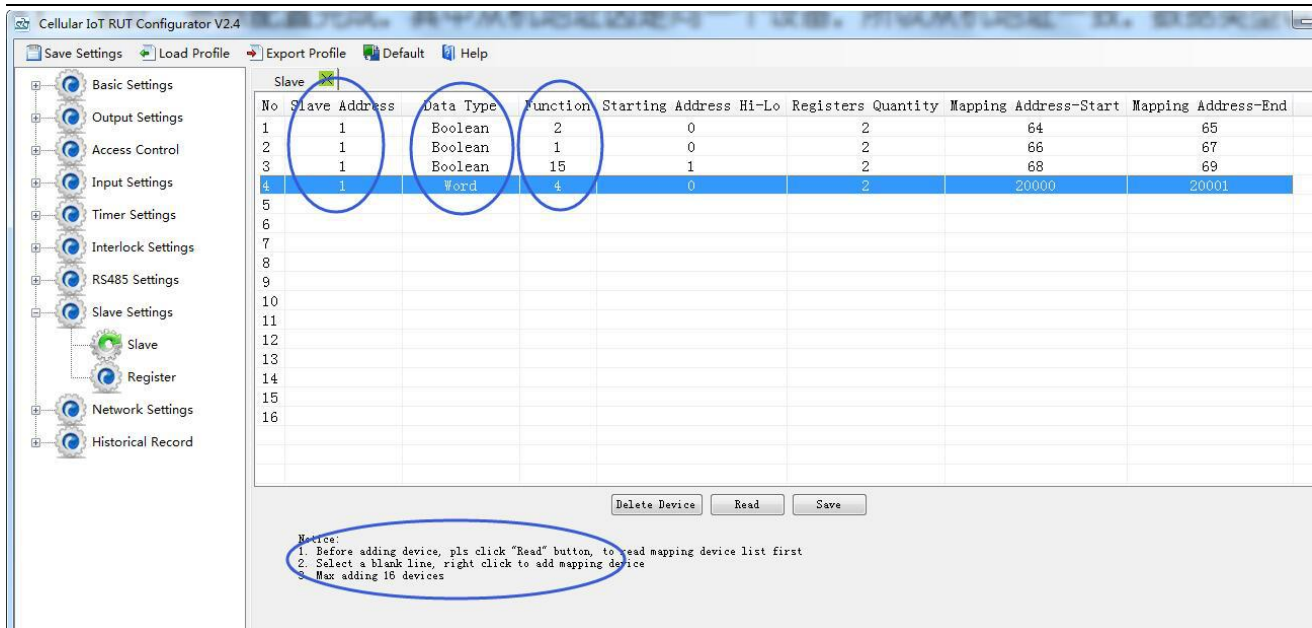

(9) Click "Save Settings" in the menu, then switch device off.

(10) Switch the DIP mode to "Run".

(11) Switch the device on, enter into working mode, device running according parameter setting.

RS485 connected as Modbus RTU Slave:

Device support Modbus RTU slave function, can connect to HMI, SCADA, DCS, MES system. It can be used for field data acquisition, remote SMS alarm, remote dial alarm and GPRS/3G/4G to cloud...

For example, when device as Modbus RTU slave, connect to HMI as below:

(1) Connect device to HMI via RS485 port, set HMI RS485 port parameter;

(2) Basic setting according (1) and (2) in "Device working self-checking";

(3) In "Basic Parameter Settings" page, set "Device ID", range is 1~247 in Modbus protocol as below:

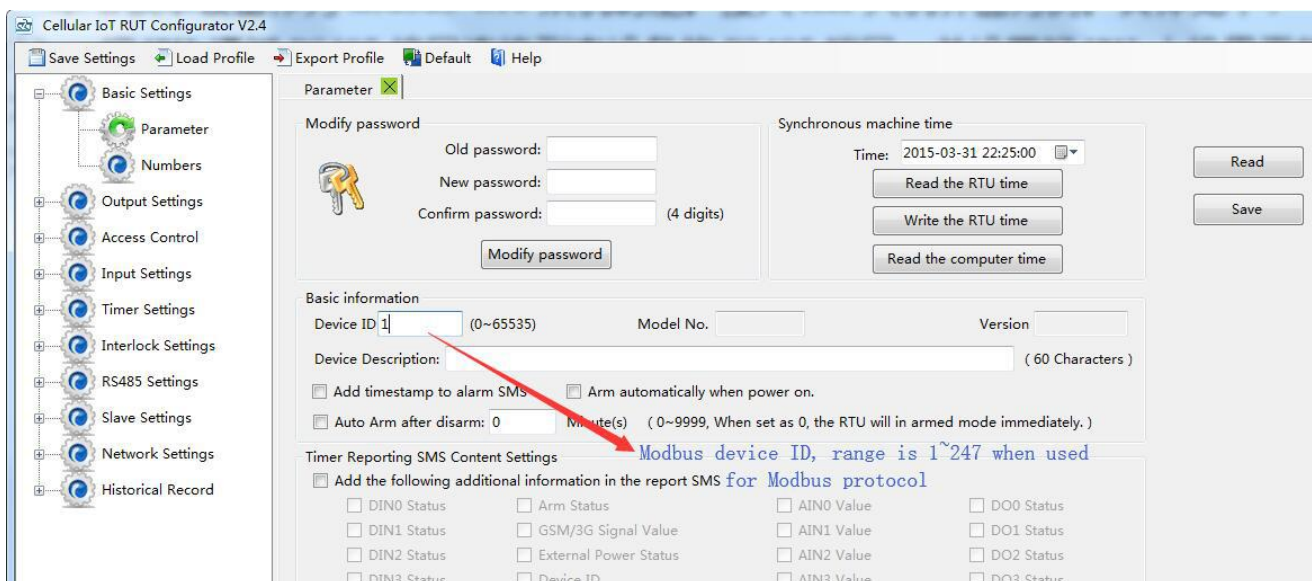

(3) In "Serial Port" setting page, set device parameter as below:

A) RS485 used as "Modbus RTU Slave";

- B) Baud Rate, Data Bit, Parity Bit, Stop Bit setting should be corresponding with HMI, otherwise commucation will be failure. If multi Masters, all Masters paramter should corresponding with device;
- C) No need set: "Scan Rate", "Time Out", "Slave Fault Verify Time";
- D) Click "Save" button.

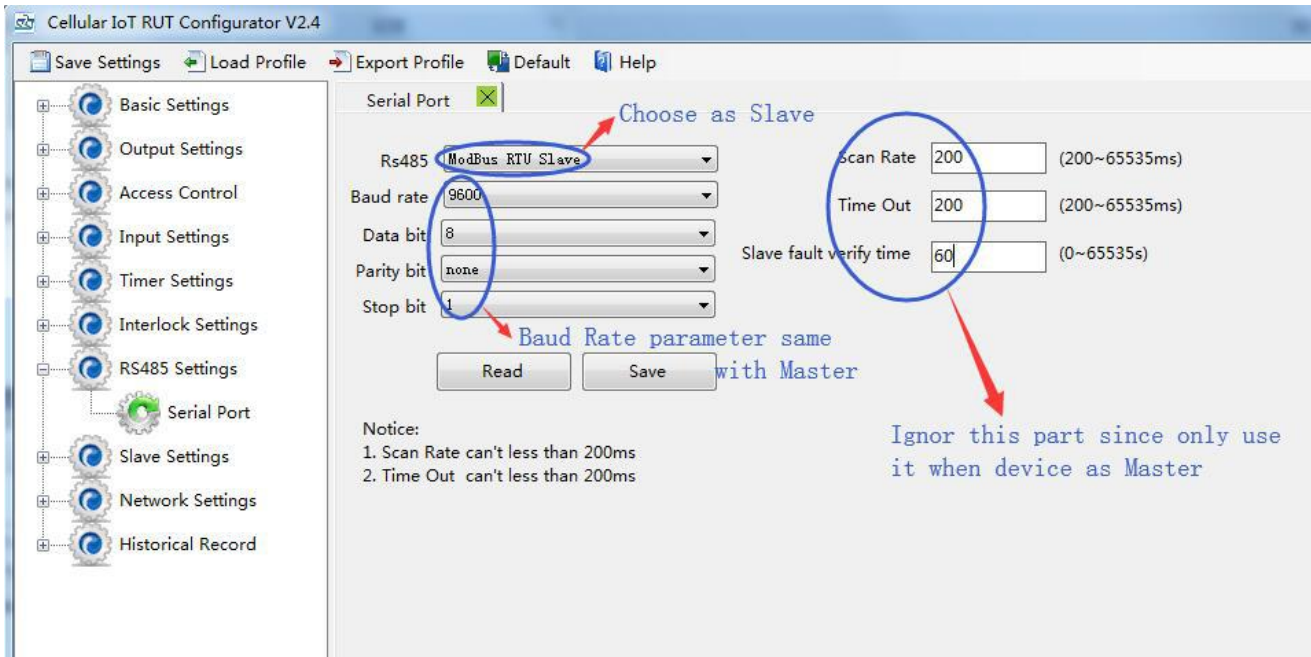

- (5) Click "Save Settings" in the menu, switch the device off;
- (6) Switch DIP mode to "Run";
- (7) In HMI configurator software, set the Modbus RTU Register address of device. Refer to [**RS485 Serial Port Setting**---->**Modbus RTU Slave Functtion**---->**Device I/O Register Address and Function code**];
- (8) Switch the device on, enter into working mode, device running according parameter setting.

Transparent Transmission As DTU:

Device can support data transparent transmission: DTU function. Could server transmit data to device via GPRS/3G/4G, device will transfer the data to RS485 port directly wihtout deal with. Once device receive data from RS485, also transmit to cloud server directly via GPRS/3G/4G, refere to "Serial Port Transparent Transmission". When device RS485 port no need mapping slave, or connect to others which is not standard Modbus RTU protocol, then can choose transparent transmission as below:

- (1) Items connect to device via RS485, set RS485 port parameter;
- (2) Basic setting according (1) and (2) in "Device working self-checking";
- (3) In "Serial Port" setting page, device parameter as below:

- A) Choose RS485 as "Transparent Transmission";
- B) Baud Rate, Data Bit, Parity Bit, Stop Bit setting should be corresponding with items, otherwise commucation will be failure. If multi items, all items paramter should corresponding with device;
- C) No need set: "Scan Rate", "Time Out", "Slave Fault Verify Time";
- D) Click "Save" button.

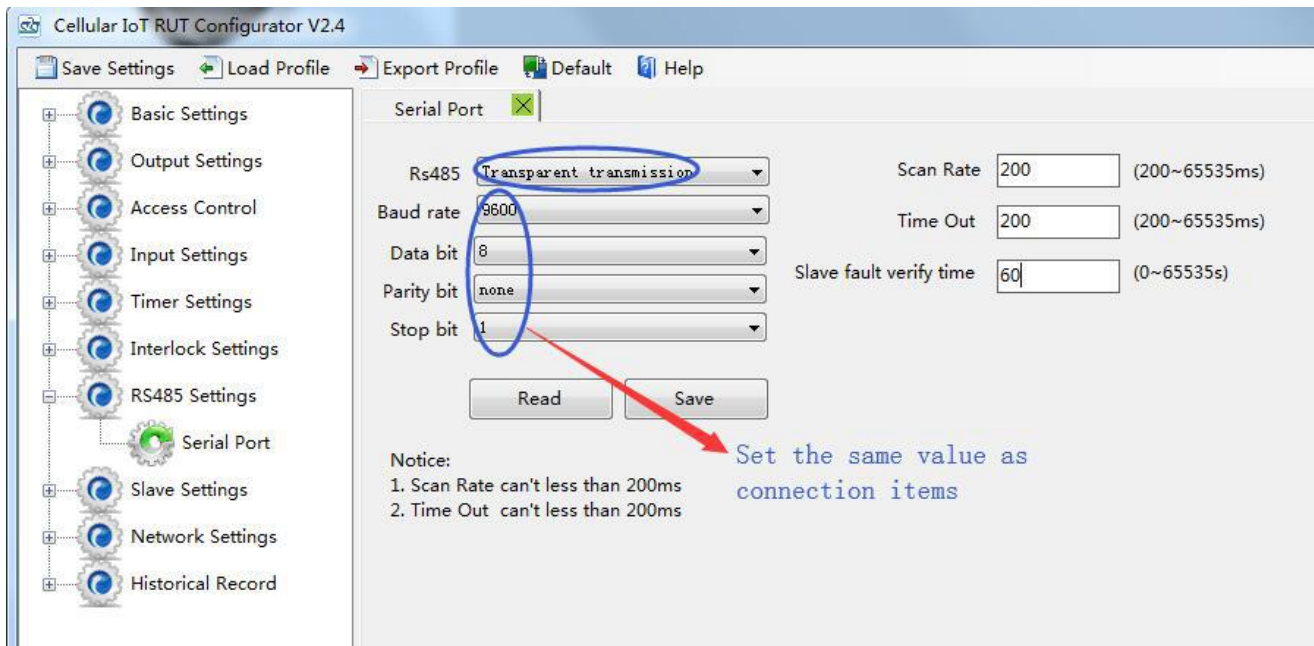

(4) In "GPRS Setting" page, set "Communication Data" as "Modbus RTU Protocol", then set "Server IP/DNS" and "Port", also can set handshake protocol like "Login Message" below:

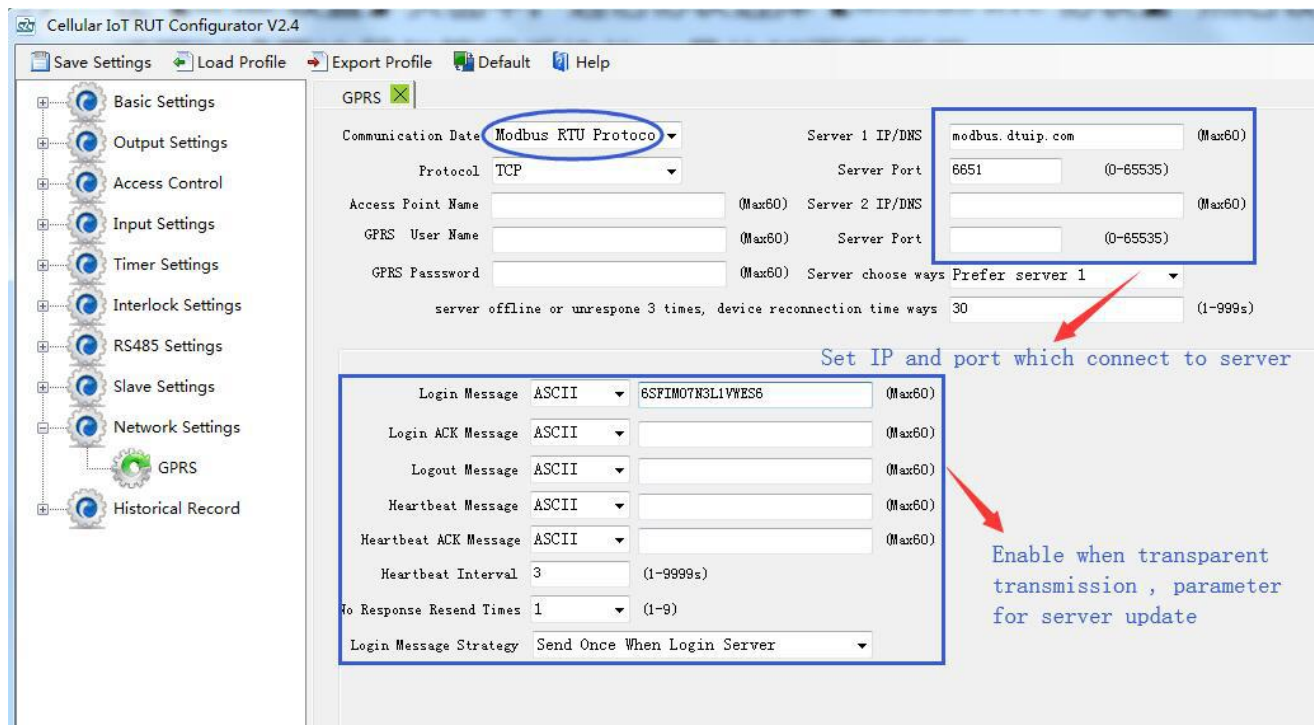

(5) Click "Save Settings" in the menu, then switch device off.

(6) Switch the DIP mode to "Run".

(7) Switch the device on, enter into working mode, device running as transparent transmission when data communication between cloud server and items.

Device connect to www.My-M2M.com cloud configuration, wechat notify application

Device can connect to cloud and SCADA via GPRS/3G/4G network, also can connect to clients own server and King Pigeon www.My-M2M.com cloud server. King Pigeon my-m2m.com cloud as sample below:

King Pigeon my m2m cloud support Modbus TCP, cloud configuration, wechat alarm function, welcomed editable function.

(1) Basic setting according (1) and (2) in "Device working self-checking";

(2) In "Basic Parameter" setting page, set device ID, range 1~247 in Modbus RTU protocol as below:

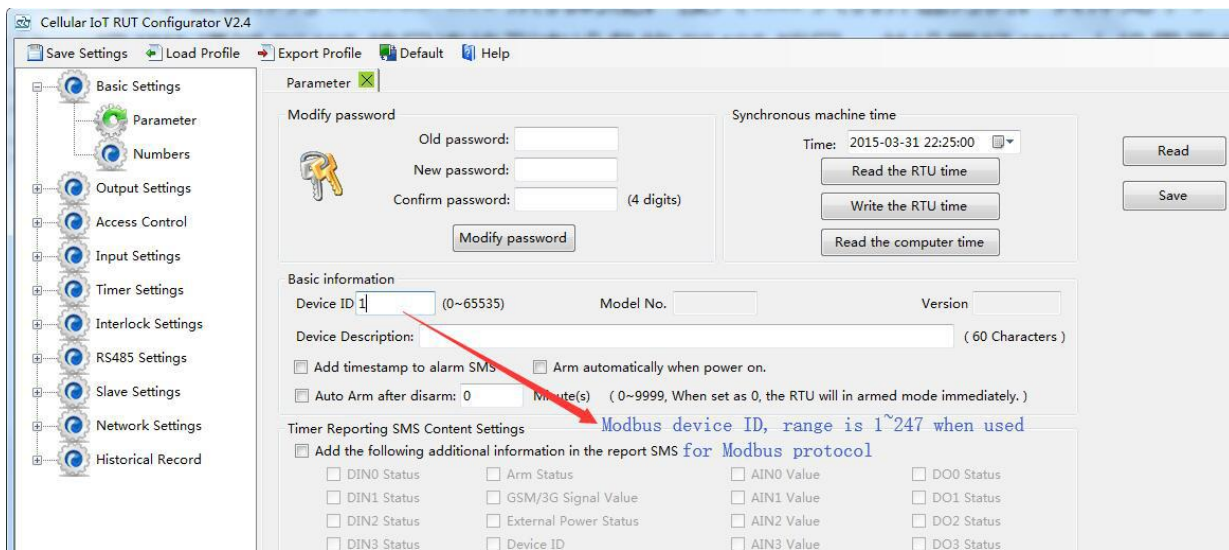

(3) In "GPRS" setting page, set parameter as below:

When Communication Data as "Modbus RTU Protocol", then server IP/DNS should be: modbus.dtuip.com, port is 6651, pls contact King Pigeon Sales for "Login Message Writing";

When Communication Data as "Modbus TCP Protocol", then server IP/DNS should be: modbus.dtuip.com, port is 6655, pls contact King Pigeon Sales for "Login Message Writing";

When Communication Data as "King Pigeon RTU/Definition Protocol", then server IP/DNS should be: rtu-m2m.com , port is 8001, pls provide device IMEI to King Pigeon Sales (Only used for S272).

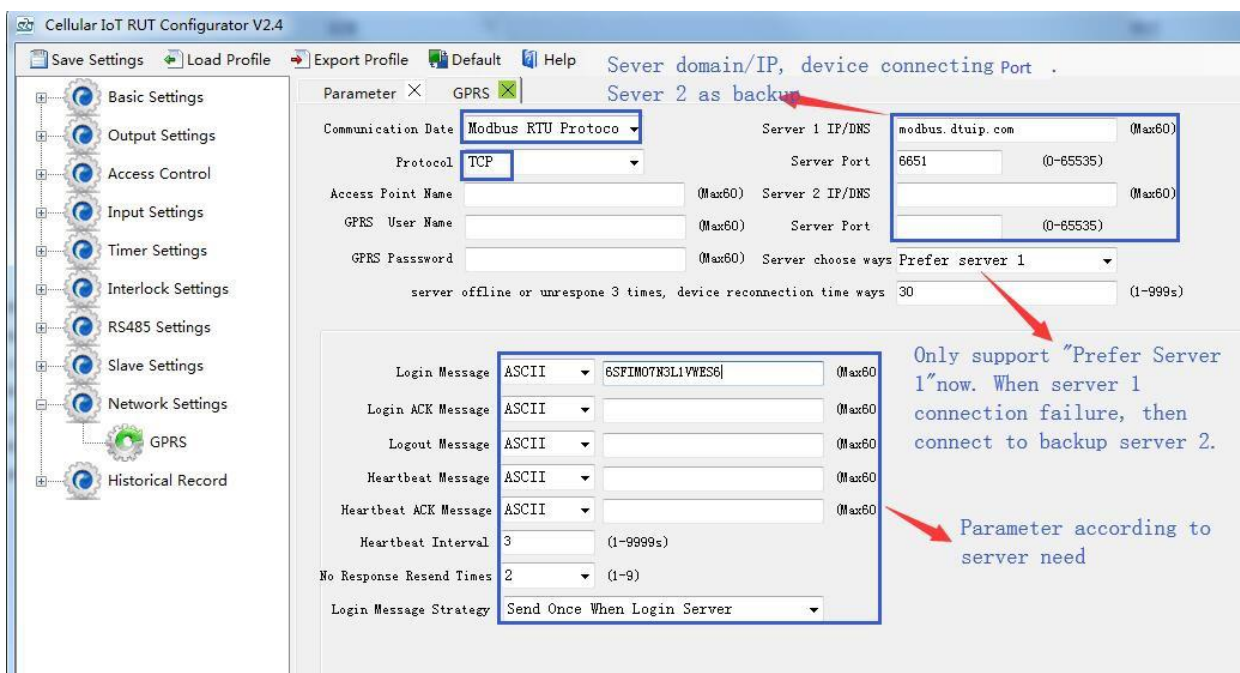

- (4) Click "Save Settings" in the menu, then switch device off.
- (5) Switch the DIP mode to "Run".
- (6) Switch the device on, enter into working mode, then Slave and Master I/O can connect to network.

8. Device SMS Command and SMS APP

The user can send SMS commands to setup or operate the device, also can use the APP to control it easier. The APP is under SMS communication, but their makes the program and operation easier than edit SMS every time.

The Android APP search "M2M RTU" or click to download link:

<http://nc-apk.wdcdn.com/9/c8/1fd8e70a8634e9b4763a6a7114888c89.apk>

The IOS APP search "M2M RTU" or click to download link (IOS 7.0 version or above support):

<https://itunes.apple.com/us/app/gsm-3g-m2m-rtu/id1095288504?l=zh&ls=1&mt=8>

Or can scan QR code below:



SMS APP interface as below:

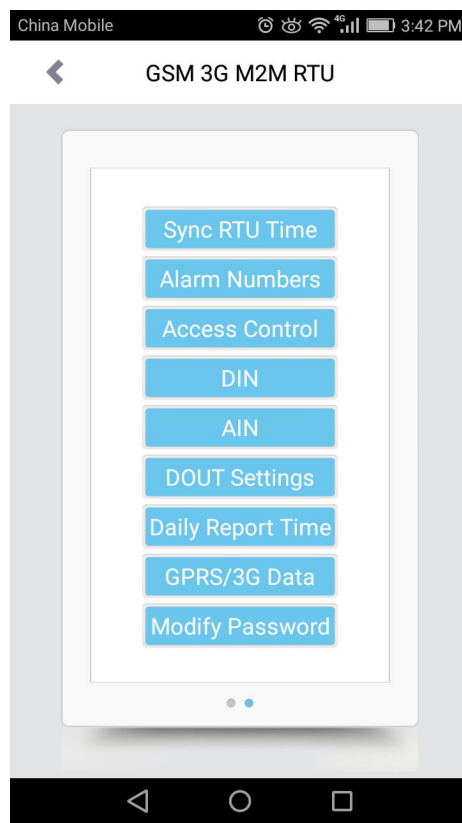
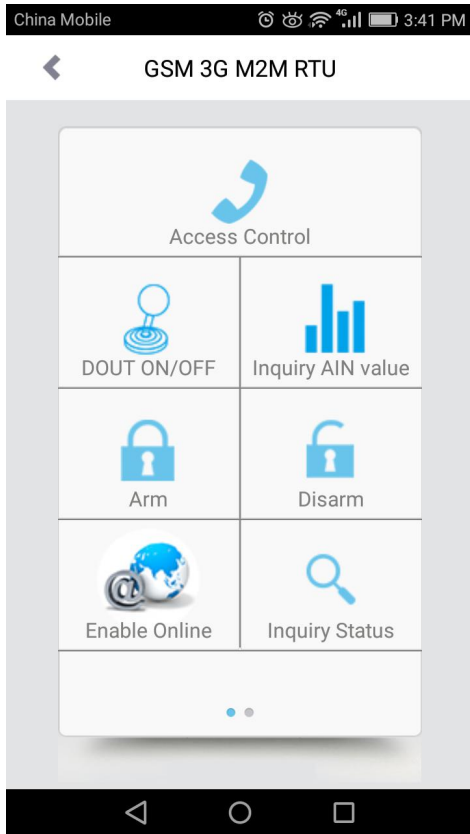

SMS Command List:

The SMS commands will be used for remote control the RTU are below:

1) **Commands error return SMS**

Event	Return SMS Content
Any incorrect Command	SMS Format Error, Please check Caps Lock in Command!

2) **External DC Status**

Event	Return SMS Content
External DC goes off	External DC Power Goes OFF
External DC Power Goes ON	External DC Power Goes ON

3) **Modify Password, 4digits, default is 1234**

SMS Command	Return SMS Content
Old Password + P + New Password	This is the New Password, please remember it carefully.

4) **Arm/Disarm SMS Command**

SMS Command	Return SMS Content	
Arm	password+AA	Armed
Disarm	password+BB	Disarmed

5) **Set RTU time**, format is 2015-05-22 15:20:30W01, the W01 stands for Monday, W07 stands for Sunday.

SMS Command	Return SMS Content
password+Dxxxx-xx-xxTxx: xx: xxWxx	xxxx(Y)XX(M)XX(D)xx(H)X(M)xx(W)

6) **Inquiry Current Status SMS Command**

SMS Command	Return SMS Content
password+EE	Armed/Disarmed Model:



	Version: IMEI: GSM Signal Value: External DC Power Goes OFF/ON
--	---

7) Setup 10 User number(Alarm Number&Access Control Number), max 21digits. (Return 0~4 or 5~9 separately while setting.)

SMS Command		Return SMS Content
Setup	password+A+series number+T+tel number Notice: Series number = 0~9	Tel1: --- Tel2: --- Tel3: 13570810254 Tel4: --- Tel5: ---
Inquiry	password+A	Return all numbers
Delete	password+A+series number	Return 0~4 or 5~9 numbers.

8) Authority User Number to access control: authorized number can dial to disarm and open the door.

SMS Command		Return SMS Content
Setup	Specified access control time: password+B+series number+S+start time+E+endtime Always can access control: password+B+series number+P Notice: Time format is 201505231230, stands for year, month, date, hour, minute.	Tel1: --- Tel2: --- Tel3: 13570810254 Tel4: --- Tel5: ---
Inquiry	password+B	Return all authorized user numbers
Delete	password+B+series number	Return all authorized user numbers

9) Setup Daily Report time

SMS Command		Return SMS Content
Setup	password+DR+series number+T+time Notice: Series number =0~9, e.g.: 1234DR1T12:30	Daily SMS Report at: xx:xx
Inquiry	password+DR	
Delete	password+DRDEL	

10) Inquiry DIN Status

SMS Command		Return SMS Content
Inquiry Status	password+DINE	DIN1:Open/Close DIN2: Open/Close -----

11) Setup AIN Name

SMS Command		Return SMS Content
Set Threshold	password+AINR+channel number+Lxxx+Hxxx	AINx: Low:xxx,High:xxx.
Inquiry Threshold	password+AINR+ channel number<nnnnnnnn>	AINx: Low:xxx, High:xxx. AINy: Low:xxx, High:xxx.
Delete Threshold	password+AINR+ channel number+DEL	
Set AIN measurement range	password+AINM+ channel number+Lxxx+Hxxx	AINx: Min:xxx,Max:xxx
Inquiry measurement	password+AINM+ channel number<nnnnnnnn>	AINx: Min:xxx, Max:xxx.



range		AINy: Min:xxx, Max:xxx.
Delete measurement range	password+AINM+channel number+DEL	
Inquiry AIN Current Value	password+AINE+channel number<nnnnnnnn>	AINx: xxxx ,+【Normal/Higher/Lower】
Inquiry All AIN Current Value	password+AINE	AIN0: xxxx ,+【Normal/Higher/Lower】 AIN1: xxxx ,+【Normal/Higher/Lower】 ----

12) SMS Control Digital Output

SMS Command		Return SMS Content
Set DO Name	password+DO+channel number+T	DOx:xxxx
Inquiry DO Name	password+DO+ channel number<nnnn>	
Delete DO Name	password+DO+ channel number+DEL	
Switch ON(Close)	password+DOC+ channel number<nnnn> , can close multi channel, till next event trigger or SMS command.	DOx: ON DOy:ON
Switch OFF(Open)	password+DOO+ channel number<nnnn>	DOx: OFF DOy:OFF
Inquiry DO Current Status	password+DOE+ channel number<nnnn>	DOx: ON/OFF DOy:ON/OFF
Inquiry all DO Current Status	password+DOE	DO1: ON/OFF DO2:ON/OFF ---
Time Switch ON (Close)	password+DOLC+ channel number<nnnn> , can close multi channel, till time setting in configurator software finished.	
Set Pulse Output time	password+DOT+xxx (3 digital, unit is seconds)	Pulse Output Time:xxxS
Inquiry pulse output time	password+DOT	Pulse Output Time:xxxS
Pulse Ouput	password+DOP+channel number<nnnn>	No SMS Return

13) Set Server Parameter(Can not setup DNS by SMS)

SMS Command		Return SMS Content
Set Server IP	password+IP+ IPaddress+P+Com port	Server: Port:
Inquiry	password+IP	
Delete	password+IPDEL	

14) Set GPRS APN/USER NAME/PASSWORD

SMS Command		Return SMS Content
Set	password+AP+apn+#+username+#+userpassword	APN:
Inquiry	password+AP	User Name:
Delete	password+APDEL	Password:

15) GPRS Online

SMS Command	Return SMS Content
password+GPRSONline	GPRS always online

16) Delete Historical Data

SMS Command	Return SMS Content
-------------	--------------------

password+HISDEL	Delete all historical records
-----------------	-------------------------------

17) Clear/Inquiry Pulse Counter Value

SMS Command		Return SMS Content
Clear Pulse Counter Value	password+DINOCLR	Clear Successfully
Inquiry Pulse Counter Value	password+PR	Counter Current Value: XX

9. Device GPRS/3G/4G Communication Protocol

Device can connect to Cloud and SCADA via GPRS/3G/4G network, support Transparent Transmission, Modbus RTU over TCP, Modbus TCP and King Pigeon RTU protocol. User also can connect device to third party cloud or server.

Device Networks Topology:

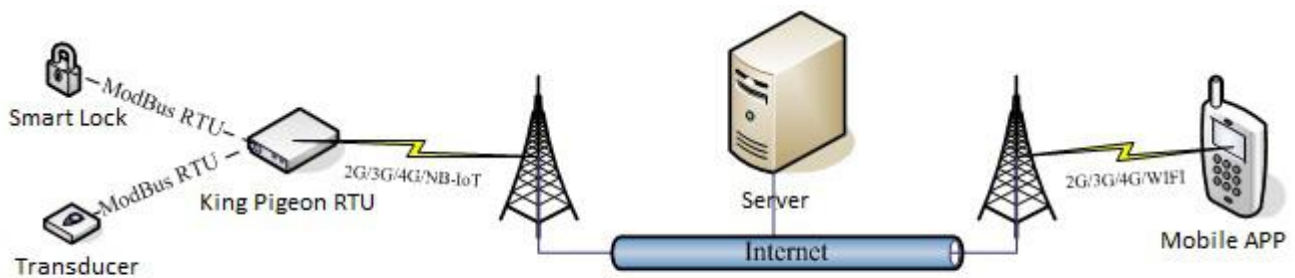

Communication Networks:

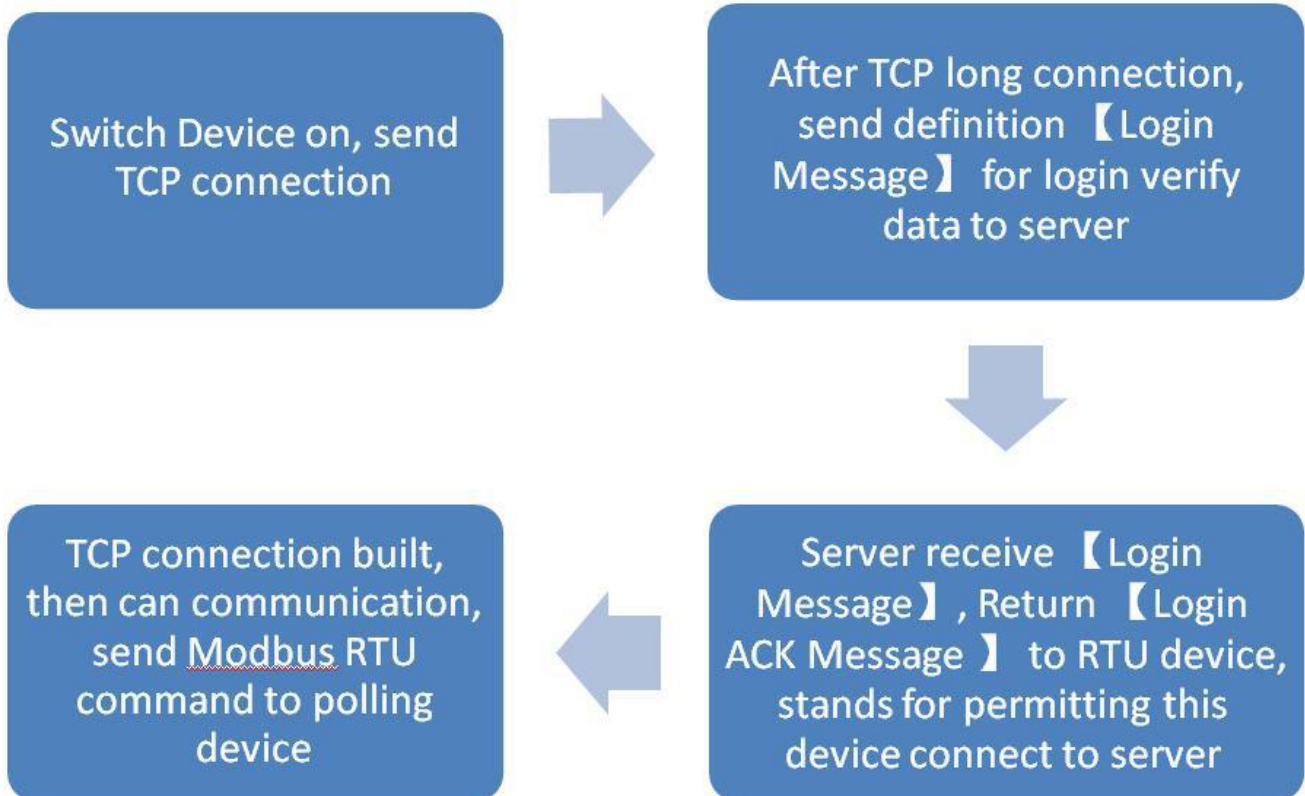

 **Message communication sequence:**

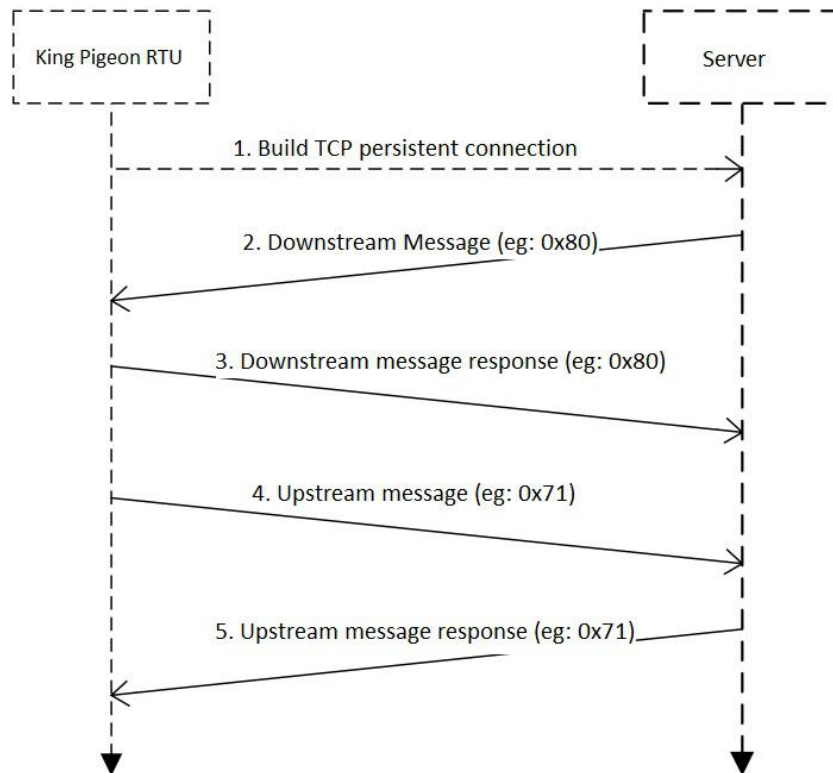

 **Transparent Transmission**

Pls refer to "Transparent Transmission" content above.

 **King Pigeon IoT RTU Protocol/ Definition Protocol**

If users need device send alarm data, or timely send data to server, can choose this communication protocol. Set "Communication Data" in "GPRS" setting page, need to choose "King Pigeon RTU/Definition protocol", "Protocol" choose TCP, set the Domain/IP/Port of connecting server, other parameter setting according to server.

Notice:

- 1) When Modbus TCP or Modbus RTU over TCP communication protocol adopted, device used as Internet remote server or slave device of cloud. So device ID is necessary for server polling device address data, and Internet remote server and cloud used for Modbus Master function.
- 2) When Modbus TCP or Modbus RTU over TCP communication protocol adopted, cloud server can remotely read and write device register address and slave mapping register address, according to Modbus TCP or Modbus RTU protocol. Device register address and function code refer to "RS485 Serial Port Setting---->Modbus RTU Slave Function---->Device I/O Register Address and Function Code"; Mapping register address and function code refer to " RS485 Serial Port Setting---->Modbus RTU Master Function---->Mapping Register List and Function Code".

 **Modbus TCP Protocol**

Device can connect to server or cloud to build TCP connection automatically via GPRS/3G/4G networks. After building TCP connection, server or SCADA or cloud can send Modbus TCP command to device for Modbus TCP communication.

Modbus RTU Over TCP

After device switched on, automatically connect to server or cloud to build TCP connection via GPRS/3G/4G networks. Users can set handshake protocol, login message, heartbeat or other parameter according to cloud server. After TCP connection, server or SCADA or cloud can send Modbus RTU command to device, to build Modbus RTU networks which based on TCP connection.

For Modbus RTU over TCP protocol, setting as below:

(1) In "Basic Parameter" setting, set device ID, range 1~247 in Modbus RTU protocol, click "Save" as below:

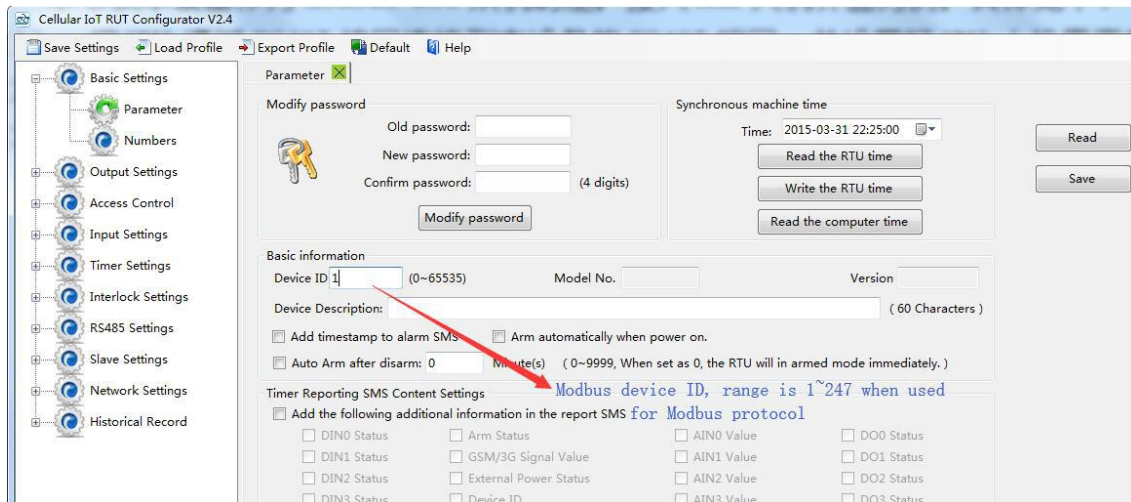

(1) In "GPRS" setting page, "Communication Data" choose "Modbus RTU Protocol", means communication with Modbus RTU over TCP. After setting server IP/DNS and other parameter, click "Save" button as below:

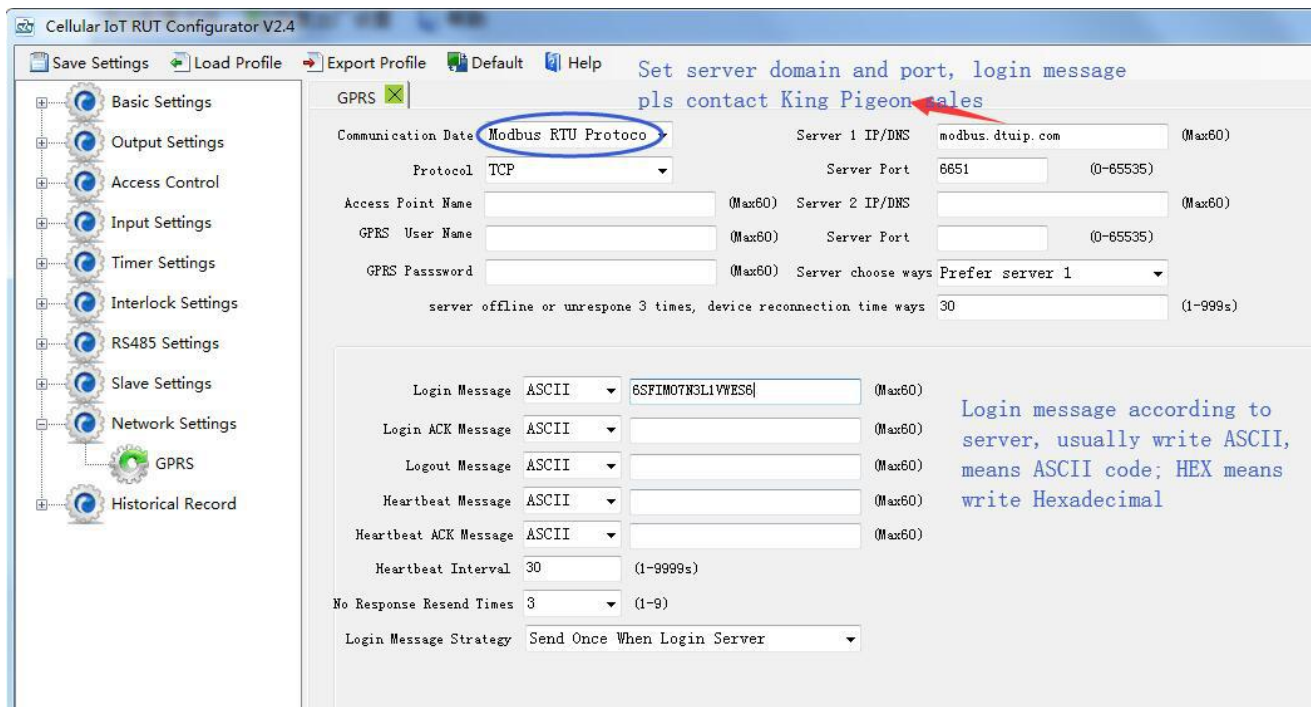

- (4) Click "Save Settings" in the menu, then switch device off.
- (5) Switch the DIP mode to "Run".
- (6) Switch the device on, enter into working mode, then Slave and Master I/O can connect to network via Modbus RTU protocol.

Modbus RTU over TCP Communication Application

Modbus RTU over TCP communication protocol application, server as Modbus (RTU) Master, device as Modbus (RTU) slave. If device ID is 1, and already connected to remote cloud server via GPRS/3G/4G networks.

Read device relay DO status:

Device's relay DO register address as holding coil, address 0~3, refer to "Device I/O Register Address and Function Code".

Master Send Data Format:

Content	Bytes	Data (H: HEX)	Description
Device Address	1	01H	01H Device, Range: 1-247, according to setting address
Function Code	1	01H	Read holding coil type, function code 01
DO Origin Register Address	2	00 00H	Range: 0000-0003, address refer to " Device I/O Register Address and Function Code "
Read DO Register Qty	2	00 04H	Range: 0001H-0004H, Read DO qty
16CRC Verify	2	3D C9	CRC0 CRC1 low byte in front, high byte in behind

Receiver Return Data Format:

Content	Bytes	Data (H: HEX)	Description												
Device Address	1	01H	01H Device, according to the data Master send												
Function Code	1	01H	Read holding coil												
Return Byte Length	1	01H	Return Data Length												
Returning Data	1	02H	02H means 4 DO status, high 4 byte invalid, low 4 Byte 2 converter Binary as below												
			<table border="1" style="width: 100%; text-align: center;"> <tr> <td>DO3(bit3)</td> <td>DO2 (bit2)</td> <td>DO1 (bit1)</td> <td>DO1 (bit0)</td> </tr> <tr> <td>0</td> <td>0</td> <td>1</td> <td>0</td> </tr> <tr> <td>Open</td> <td>Open</td> <td>Close</td> <td>Open</td> </tr> </table>	DO3(bit3)	DO2 (bit2)	DO1 (bit1)	DO1 (bit0)	0	0	1	0	Open	Open	Close	Open
			DO3(bit3)	DO2 (bit2)	DO1 (bit1)	DO1 (bit0)									
			0	0	1	0									
Open	Open	Close	Open												
Device current relay status: DO0,DO2,DO3 = Open, DO1= Close															
16CRC Verify	2	DO 49H	CRC0 CRC1 low byte in front, high behind												

Example: Read 4 relays DO0~DO3 status, device address as 1 :

Server send: 01 01 00 00 00 04 3D C9

01H= Device address; 01H= Read relay function code; 00 00H= Read starting relay DO0 address;



00 04H= Read serial 4 DO status; 3D C9H CRC= Verify.

Device answer: 01 01 01 02 D0 49

01H= Device address; 01H= Read relay function code; 01H= Return data byte qty; 02H= Returning data, stands for Binary 0000 0010 high 4 byte invalid, low 4 byte 0010, sort as DO3 DO2 DO1 DO0 status, D0 49HCRC verify. If read DO or multi DO status, only need to revise " DO Origin Register Address " and " Read DO Register Qty ", calculate the CRC again, returning data according to description data.

Control device DO output:

1) Control 1 channel device DO output

Master Send Data Format:

Content	Bytes	Data (H: HEX)	Description
Device Address	1	01H	01H Device, Range: 1-247, according to setting address
Function Code	1	05H	Write single holding coil type, function code 05
DO Register Address	2	00 00H	Range: 0000-0003, stands for DO0-DO3
Active	2	FF 00H	This value: FF 00H or 00 00H, FF 00H= Close relay, 00 00H= Open relay
16CRC Verify	2	8C 3AH	CRC0 CRC1 low byte in front, high behind

Receiver Return Data Format:

Content	Bytes	Data (H: HEX)	Description
Device Address	1	01H	01H Device, according to the data Master send
Function Code	1	05H	Write single holding coil type, function code 05
DO Register Address	2	00 00H	Range: 0000-0003, stands for DO0-DO3
Active	2	FF 00H	This value: FF 00H or 00 00H, FF 00H= Already activated close relay, 00 00H= Already activated open relay
16CRC Verify	2	8C 3AH	CRC0 CRC1 low byte in front, high behind

Example: Control relay DO0 close, then:

Server send: 01 05 00 00 FF 00 8C 3A

01H= Device address; 05H= Control single relay command; 00 00 H DO0= Address; FF 00H= DO0 close; 8C 3A H16 byte CRC verify.

Device answer: 01 05 00 00 FF 00 8C 3A

01H= Device address; 05H= Control single relay command; 00 00 H DO0= Address; FF 00H= Active DO0 close; 8C 3AH 16 byte CRC verify.

If single control other relay outputs, only need to change "DO Register Address" and "Active", calculate CRC verify again.



2) Multi control DO outputs

Master Send Data Format:

Content	Bytes	Data (H: HEX)	Description												
Device Address	1	01H	01H Device, according to setting address												
Function Code	1	0FH	Write multi holding coil												
DO Starting Register Address	2	00 00H	Range: 0000-0003, stands for DO0-DO3												
Control Relay Qty	2	00 04H	Qty: 0-4												
Write Byte Qty	1	01H	Write 1 byte, since device only 4DO, use 4 binary can do it												
Writing Data	1	0FH	0FH stands for 4 DO status, high 4 byte invalid, low 4 byte F converter to binary as below <table border="1" style="margin: 5px auto;"> <tr> <td>DO3(bit3)</td> <td>DO2 (bit2)</td> <td>DO1 (bit1)</td> <td>DO1 (bit0)</td> </tr> <tr> <td>1</td> <td>1</td> <td>1</td> <td>1</td> </tr> <tr> <td>Active close</td> <td>Active close</td> <td>Active close</td> <td>Active close</td> </tr> </table> <p>1= Active close, 0= Active open</p>	DO3(bit3)	DO2 (bit2)	DO1 (bit1)	DO1 (bit0)	1	1	1	1	Active close	Active close	Active close	Active close
DO3(bit3)	DO2 (bit2)	DO1 (bit1)	DO1 (bit0)												
1	1	1	1												
Active close	Active close	Active close	Active close												
16CRC Verify	2	7E 92H	CRC0 CRC1 low byte in front, high behind												

Receiver Return Data Format:

Content	Bytes	Data (H: HEX)	Description
Device Address	1	01H	01H Device, according to setting address
Function Code	1	0FH	Write multi holding coil
DO Register Address	2	00 00H	Range: 0000-0003, stands for DO0-DO3
Active Relay Qty	2	00 04H	Qty: 0-4, stands for how many relays already activated
16CRC Verify	2	54 08H	CRC0 CRC1 low byte in front, high behind

Example: Close device 4 DO at same time, then:

Server send: 01 0F 00 00 00 04 01 0F 7E 92

01H= Device address; 0FH= Control multi relay; 00 00H= Relay DO0 starting address; 00 04H= Control 4 relays; 01H= Send data qty; 0FH= Data sent converter to binary 0000 1111 high 4 byte invalid, low 4 byte 1111 sort to match DO3 DO2 DO1 DO0, 1 stands for close relay, 7E 92H CRC verify.

Device answer: 01 0F 00 00 00 04 54 08

01H= Device address; 0FH= Control multi relay; 00 00H= Relay DO0 starting address; 00 04H= Activated 4 relays; 54 08H CRC verify.

If need to control multi relays at same time, only need to change "Relay Starting Address", "Control Relay Qty", "Write Data" and calculate "CRC Verify" again.



Read device DIN status:

Master Send Data Format:

Content	Bytes	Data (H: HEX)	Description
Device Address	1	01H	01H Device, Range: 1-247, according to setting address
Function Code	1	02H	02 read input coil DIN status
DIN Register Address	2	00 00H	Range: 0000-0007, stands for DIN0-DIN7
Read DIN Register Qty	2	00 08H	Read qty of DIN status
16CRC Verify	2	79 CCH	CRC0 CRC1 low byte in front, high behind

Receiver Return Data Format:

Content	Bytes	Data (H: HEX)	Description																								
Device Address	1	01H	01H Device, Range: 1-247, according to setting address																								
Function Code	1	02H	02 read input coil DIN status																								
Return Bytes Qty	1	01H	Range: 0000-0007, stands for DIN0-DIN7																								
Returning Data	1	FFH	FFH converter to binary 1111 1111 from high to low byte, stands for DIN7-DIN0 status <table border="1" style="margin-left: 20px;"> <thead> <tr> <th>DIN7 (bit7)</th> <th>DIN6 (bit6)</th> <th>DIN5 (bit5)</th> <th>DIN4 (bit4)</th> <th>DIN3 (bit3)</th> <th>DIN2 (bit2)</th> <th>DIN1 (bit1)</th> <th>DIN0 (bit0)</th> </tr> </thead> <tbody> <tr> <td>1</td> <td>1</td> <td>1</td> <td>1</td> <td>1</td> <td>1</td> <td>1</td> <td>1</td> </tr> <tr> <td>Close</td> <td>Close</td> <td>Close</td> <td>Close</td> <td>Close</td> <td>Close</td> <td>Close</td> <td>Close</td> </tr> </tbody> </table> 1= Close, 0= Open	DIN7 (bit7)	DIN6 (bit6)	DIN5 (bit5)	DIN4 (bit4)	DIN3 (bit3)	DIN2 (bit2)	DIN1 (bit1)	DIN0 (bit0)	1	1	1	1	1	1	1	1	Close	Close	Close	Close	Close	Close	Close	Close
DIN7 (bit7)	DIN6 (bit6)	DIN5 (bit5)	DIN4 (bit4)	DIN3 (bit3)	DIN2 (bit2)	DIN1 (bit1)	DIN0 (bit0)																				
1	1	1	1	1	1	1	1																				
Close	Close	Close	Close	Close	Close	Close	Close																				
16CRC Verify	2	E1 C8H	CRC0 CRC1 low byte in front, high behind																								

Example: Inquiry device 8 DIN data at same time, then:

Server send: 01 02 00 00 00 08 79 CC

01H= Device address; 02H= Inquiry DIN status; 00 00H=DIN= Starting address; 00 08H= Serial reading 8 DIN status; 79 CC H CRC verify.

Device answer: 01 02 01 FF E1 C8

01H= Device address; 02H= Inquiry DIN status; 01H= Returning data bytes qty; FFH DIN status, every byte stands for one DIN status, FFH converter to binary 1111 1111 from high to low byte, stands for DIN7-DIN0 status, 0= Open, 1= Close, E1 C8H 16 byte CRC verify.

If need to inquiry multi DIN status, only need to change "DIN Starting Address", "Reading DIN Register Qty", calculate CRC verify again.



Read device AIN DIN pulse count value, temperature and humidity value, external power voltage value:

Master Send Data Format:

Content	Bytes	Data (H: HEX)	Description
Device Address	1	01H	01H Device, Range: 1-247, according to setting address
Function Code	1	04H	04 read input register
Register Starting Address	2	00 00H	One address can read 2 bytes. AIN address range: 0000-000BH, One AIN data take two address, temperature address: 0018H, humidity address: 0019H, DIN1 count value address: 001A, 001B External power voltage address: 000E。
Read Register Qty	2	00 1CH	Read qty of input register, read AIN0 to DIN0 count value address, total 28 register, 0000H to 0001BH.
16CRC Verify	2	F1 C3H	CRC0 CRC1 low byte in front, high behind

Receiver Return Data Format:

Content	Bytes	Data (H: HEX)	Description																																								
Device Address	1	01H	01H Device, Range: 1-247, according to setting address																																								
Function Code	1	04H	04 read input register																																								
Data Bytes Range	1	38H	One address can read 2 bytes. AIN address range: 0000-000BH, One AIN data take two address, temperature address: 0018H, humidity address: 0019H, DIN0 count value address: 001A,001B External power voltage address: 000E。																																								
Returning Data	N	00 00 00	N= Returning bytes, sample data 56 points: <table border="1" style="width: 100%; border-collapse: collapse;"> <thead> <tr> <th>AIN</th> <th>AIN0</th> <th>AIN1</th> <th>AIN2</th> <th>AIN3</th> <th>AIN4</th> <th>AIN5</th> </tr> </thead> <tbody> <tr> <td>Receivin g Data</td> <td>00 00 00 E7H</td> <td>00 00 00 DDH</td> <td>00 00 00 DDH</td> <td>00 00 00 DCH</td> <td>00 00 00 DEH</td> <td>00 00 00 DFH</td> </tr> <tr> <td>Decimal Value</td> <td>194</td> <td>207</td> <td>0</td> <td>0</td> <td>0</td> <td>0</td> </tr> <tr> <td>Real Value</td> <td>1.94</td> <td>2.07</td> <td>0</td> <td>0</td> <td>0</td> <td>0</td> </tr> <tr> <td>Other Value</td> <td>External Power Voltage</td> <td>Temperatur e</td> <td>Humidity</td> <td colspan="2">DIN0 Count Value</td> </tr> <tr> <td>Receivin</td> <td>04 C6H</td> <td>0B 36H</td> <td>1B E4H</td> <td colspan="2">00 00 00 0B</td> </tr> </tbody> </table>	AIN	AIN0	AIN1	AIN2	AIN3	AIN4	AIN5	Receivin g Data	00 00 00 E7H	00 00 00 DDH	00 00 00 DDH	00 00 00 DCH	00 00 00 DEH	00 00 00 DFH	Decimal Value	194	207	0	0	0	0	Real Value	1.94	2.07	0	0	0	0	Other Value	External Power Voltage	Temperatur e	Humidity	DIN0 Count Value		Receivin	04 C6H	0B 36H	1B E4H	00 00 00 0B	
		AIN		AIN0	AIN1	AIN2	AIN3	AIN4	AIN5																																		
		Receivin g Data		00 00 00 E7H	00 00 00 DDH	00 00 00 DDH	00 00 00 DCH	00 00 00 DEH	00 00 00 DFH																																		
		Decimal Value		194	207	0	0	0	0																																		
		Real Value		1.94	2.07	0	0	0	0																																		
		Other Value		External Power Voltage	Temperatur e	Humidity	DIN0 Count Value																																				
		Receivin		04 C6H	0B 36H	1B E4H	00 00 00 0B																																				
		E7 00 00																																									
		00 DD 00																																									
		00 00 DD																																									
00 00 00																																											
DC 00 00																																											
00 DE 00																																											
00 00 DF																																											
00 00 00																																											
00 04 C6																																											
01 9A 00																																											
00 00 01																																											
00 01 00																																											



		01 00 01 00 01 00 01 00 01 0B 36 1B E4 00 00 00 0BH	g Data Decimal Value Real Value				
				1222	2870	7140	11
				12.22V	28.7°C	71.4%RH	11 times
			AIN, External Power Voltage, Temperature, Humidity real value=Register value/100.				
16CRC Verify	2	A9 3CH	CRC0 CRC1 low byte in front, high behind				

Example: Inquiry device 28 input type register at same time, start from address 0. Include 6 AIN, one device temperature, humidity, external power voltage, DIN0 count value, then:

Server send: 01 04 00 00 00 1C F1 C3

01H= Device address; 04H= Read input register value; 00 00H AIN0= Starting address; 00 1CH= Serial reading 28 input register value; F1 C3H CRC verify.

Device answer: 01 04 38 00 00 00 E7 00 00 00 DD 00 00 00 DD 00 00 00 DC 00 00 00 DE 00 00 00 DF 00 00 00 00 04 C6 01 9A 00 00 00 01 00 01 00 01 00 01 00 01 00 01 00 01 0B 36 1B E4 00 00 00 0B A9 3C

01H= Device address; 04H= Read input register value; 56 bytes data after 38H, 00 00 00 E7H AIN0 value, 00 00 00 0DD AIN1 value, 00 00 00 DDH AIN2 value, 00 00 00 DCH AIN3 value, 00 00 00 DEH AIN4 value, 00 00 00 DFH AIN5 value, 00 00 00 00H invalid value, 04 C6H external power voltage value, 01 9A 00 00 00 01 00 01 00 01 00 01 00 01 00 01 00 01 00 01 0B 36H temperature value, 1B 36H humidity value, 00 00 00 0BH DIN0 count value, A9 3C CRC verify.

Read Boolean mapping address data, belong to holding coil type:

Master Send Data Format:

Content	Bytes	Data (H: HEX)	Description
Device Address	1	01H	01H Device, Range: 1-247, according to setting address
Function Code	1	01H	Read Holding Coil type, Function Code 01
Boolean Register Starting Address	2	00 40H	Range: 0040H-007FH, Address refer to "Mapping Register Address and Function Code"
Read Register Qty	2	00 0AH	Range: 0001H-0040H, Boolean mapping address, total 64 address
16CRC Verify	2	BD D9H	CRC0 CRC1 low byte in front, high behind

Receiver Return Data Format:

Content	Bytes	Data (H: HEX)	Description
Device Address	1	01H	01H Device, according to the data Master send
Function Code	1	01H	Read Holding Coil
Return Bytes Length	1	02H	Return data length



Returning Data	N N= Returni ng bytes length	73 01H	High byte means low address data, low byte means high data, According to Modbus protocol, fix 73 01H real value to 01 73H converter binary as below:								
			BIT Position	Bit15	Bit 14	Bit 13	Bit 12	Bit 11	Bit 10	Bit 9	Bit8
			Boolean Address	Invalid	Invalid	Invalid	Invalid	Invalid	Invalid	73	72
			Value	0	0	0	0	0	0	0	1
			BIT Position	Bit7	Bit6	Bit5	Bit4	Bit3	Bit2	Bit1	Bit0
			Boolean Address	71	70	69	68	67	66	65	64
			Value	0	1	1	1	0	0	1	1
			Eg: Read 10 value, high 10 byte address value looked as invalid								
16CRC Verify	2	5D 0CH	CRC0 CRC1 low byte in front, high behind								

Example: Read 10 mapping Boolean value starting from address 64, then:

Server send: 01 01 00 40 00 0A BD D9

01H= Device address; 01H= Read holding coil; 00 40H= Read Boolean value starting from address 64; 00 0AH= Serial reading 10 Boolean status; BD D9H CRC verify.

Device answer: 01 01 02 73 01 5D 0C

01H= Device address; 01H= Read holding coil; 02H= Returning data bytes; 73 01H= 10 Boolean status read, refer to table above; 5D 0CH CRC verify.

Revise Boolean mapping address data, belong to holding coil type:

If need to revise slaves connected, need to add slave and use function code 15 for mapping command in configurator software. After mapping address value changed, will revise to write RS485 matched slave address data.

Master Send Data Format:

Content	Bytes	Data (H: HEX)	Description
Device Address	1	01H	01H Device, Range: 1-247, according to setting address
Function Code	1	05H	Write single Holding Coil type, Function Code 05
Boolean Mapping Register Address	2	00 40H	Range: 0040H-007FH, address refer to "Mapping Register Address and Function code"
Writing Value	2	FF 00H	This value: FF 00H or 00 00H, FF 00H= Write 1, 00 00H= Write 0
16CRC Verify	2	8D EEH	CRC0 CRC1 low byte in front, high behind

Receiver Return Data Format:

Content	Bytes	Data (H: HEX)	Description
---------	-------	---------------	-------------



Device Address	1	01H	01H Device, according to the data Master send
Function Code	1	05H	Write single Holding Coil type, Function Code 05
Boolean Register Address	2	00 40	Range: 0040H-007FH, address refer to "Mapping Register Address and Function code"
Writing Value	2	FF 00H	This value: FF 00H or 00 00H, FF 00H= Write 1, 00 00H= Write 0
16CRC Verify	2	8D EEH	CRC0 CRC1 low byte in front, high behind

Example: Revise Boolean mapping address 64 status value, revise to 1, then:

Server send: 01 05 00 40 FF 00 8D EE

01H= Device address; 05H= Revise Boolean value; 00 40 H= Revise mapping address; FF 00H= Write 1, 8D EEH16 byte CRC verify.

Device answer: 01 05 00 40 FF 00 8D EE

01H= Device address; 05H= Revise Boolean value; 00 40 H= Revise mapping address; FF 00H= Write 1, 8D EEH16 byte CRC verify.

If need revise multi, pls refer to Modbus protocol, Function code 15.

Read data type mapping address, belong to holding register:

Master Send Data Format:

Content	Bytes	Data (H: HEX)	Description
Device Address	1	01H	01H Device, Range: 1-247, according to setting address
Function Code	1	03H	03 command read holding register
Mapping Register Starting Address	2	4E 20H	One address can read 2 bytes. Address range: 4E20H-501CH, mapping data type address range, address refer to "Mapping Register Address and Function code"
Read Mapping Register Qty	2	00 0AH	Read qty of input register
16CRC Verify	2	3D 2FH	CRC0 CRC1 low byte in front, high behind

Receiver Return Data Format:

Content	Bytes	Data (H: HEX)	Description
Device Address	1	01H	01H Device, Range: 1-247, according to setting address
Function Code	1	03H	04 command read input register
Data Bytes Range	1	14H	One address can read 2 bytes.
Returning	N=	00 14 00 1E 00	N= Returning bytes, sample data 56 points:



Data	Returnin g Bytes	28 00 32 00 4B 00 41 00 0A 00 25 00 14 00 2AH	Mapping Address	20000	20001	20002	20003	20004
			Receive Data	00 14H	00 1EH	00 28H	00 32H	00 4BH
			Mapping Address	20005	20006	20007	20008	20009
			Receive Data	00 41H	00 0AH	00 25	00 14	00 2A
			Mapping address data real value need to calculate slave mapping data type according device RS485 connected, refer to "Mapping Register Address and Function code"					
16CRC Verify	2	FB 34H	CRC0 CRC1 low byte in front, high behind					

Example: Read 10 mapping address data, start from 20000, then:

Server send: 01 03 4E 20 00 0A D3 2F

01H= Device address; 03H= Read holding register; 4E 20H= Read starting address, decimal 20000 00 0AH read 10 register value, D3 2FH 16 byte CRC verify.

Device answer: 01 03 14 00 14 00 1E 00 28 00 32 00 4B 00 41 00 0A 00 25 00 14 00 2A FB 34

01H= Device address; 03H= Read holding register; 14H return 20 bytes, 00 14 00 1E 00 28 00 32 00 4B 00 41 00 0A 00 25 00 14 00 2A return data, refer to table above, FB 34H 16 byte CRC verify.

Revise data type mapping address, belong to holding register:

If need to revise slave data which RS485 connected, need to add slave and use function code 16 for mapping command in configurator software. After mapping address value changed, will revise to write RS485 matched slave address data.

If the data type of address 20000 mapping slaves is signed-int AB:

Master Send Data Format:

Content	Bytes	Data (H: HEX)	Description
Device Address	1	01H	01H Device, Range: 1-247, according to setting address
Function Code	1	06H	Write single holding register
Mapping Register Address	2	4E 20H	Address range: 4E20H-501CH, mapping data type address range, address refer to "Mapping Register Address and Function code"
Writing Data	2	00 64H	Sample data writing value is decimal 100
16CRC Verify	2	9E C3H	CRC0 CRC1 low byte in front, high behind

Receiver Return Data Format:

Content	Bytes	Data (H: HEX)	Description
Device Address	1	01H	01H Device, Range: 1-247, according to setting address



Function Code	1	06H	Write single holding register
Mapping Register Address	2	4E 20H	Address range: 4E20H-501CH, mapping data type address range, address refer to "Mapping Register Address and Function code"
Writing Data	2	00 64H	Writing 100 successfully
16CRC Verify	2	9E C3H	CRC0 CRC1 low byte in front, high behind

Example: If the data type of address 20000 mapping salves is signed-int AB, revise mapping address 20000 register to 100, then:

Server send: 01 06 4E 20 00 64 9E C3

01H= Device address; 06H= Revise single holding register value, 4E 20H= Revise address 20000 register value, 00 64H= Write to decimal value 100, 9E C3 H16 byte CRC verify.

Device answer: 01 06 4E 20 00 64 9E C3

01H= Device address; 06H= Revise single holding register value, 4E 20H= Revise address 20000 register value, 00 64H= Revise to decimal value 100, 9E C3 H16 byte CRC verify.

If need to revise multi data type mapping address, refer to Modbus protocol, Function code 16.



MQTT

Introduction to MQTT

MQTT is a client-server based message publish/subscribe transfer protocol. The MQTT protocol is lightweight, simple, open, and easy to implement. These characteristics make it applicable to a wide range. In many cases, including restricted environments, such as: machine-to-machine (M2M) communication and Internet of Things (IoT). It has been widely used in communication sensors via satellite links, occasionally dialed medical devices, smart homes, and some miniaturized devices. The MQTT protocol runs on TCP/IP or other network protocols and provides orderly, lossless, bidirectional connections.

MQTT implementation principle

There are three kinds of identities in the MQTT protocol: publisher (Publish), broker (Broker) (server), and subscriber (Subscribe). Among them, the publisher and subscriber of the message are both clients, the message broker is the server, and the message publisher can also be a subscriber. Take S27X connected to King Pigeon cloud 2.0 platform as an example:

When the device publish I/O point data:

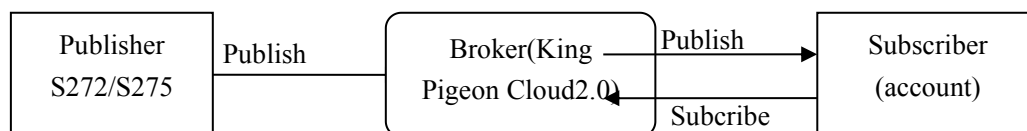

When the customer control the device:

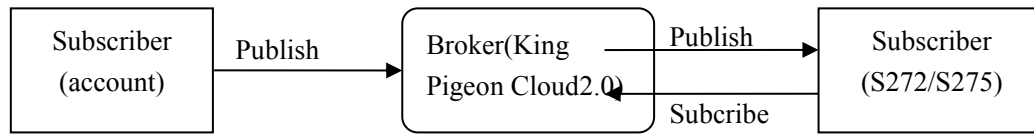

Configuration:

Domain: (King Pigeon Cloud 2.0 default:mqtt.dtuip.com)

Server Port : Broker Server Port number (King Pigeon Cloud 2.0 default:1883)

Subscribe topic: Client subscribe topic

Publish topic: Device publish data topic

MQTT Client ID: The unique identity of the device, which can be a serial number, device ID, or IMEI(King Pigeon Cloud 2.0 default is serial number)

MQTT user name: Device's account on the broker server (King Pigeon Cloud 2.0 default is MQTT)

MQTT password: Password of device's account on the broker server(King Pigeon Cloud 2.0 default is MQTTPW)

After the configuration is complete, the client will initiate a connection to the server:

CONNECT: The client sends a "CONNECT" connection message request to the server;

CONNACK: The server responds with a "CONNACK" confirmation connection message, indicating that the connection is successful;

After the client establishes a connection, it is a long connection, and the client can publish or subscribe to the message on the server;

Take the device and the client's mobile phone as the client:

After the device publishes the topic on the broker proxy server, the customer can view the data through subscription. That is, the device is the publisher and the customer's mobile phone is the subscriber.

Users can also publish topics through the MQTT server to control the device. That is, the user is the publisher and the device is the subscriber.

Payload data format of device publish message

```
Publish Topic: MQTT client ID (filled in configuration software)
{
  "sensorDatas":
  [
    {
      "flag": "DI1",           //Read and write flag
      "switcher": 1          //data type and value
    },
    {
      "flag": "AI1",
      "value": 10.00
    }
  ]
  {
    "flag": "REG20000",      // Register address and value
  }
}
```



```

        "value":1.00
    }

    ],
    "time":"1591841863",
    //Time stamp (When power on,first time connection no time stamp,later connections
have time stamp)
    "state":"alarm",
    //Alarm and recovery (only for alarm or recovery data, but not for timely report)
    "retransmit":"enable"
    //Historical data (only for re-transmission of historical data, but not for real-time data)
}

```

Note:

//Read and write flag: the character is "flag", followed by "read and write identification of IO data points"

//Data type and value:

1. Switch-type data: the character is "switcher", followed by "0" or "1" (0 open, 1 closed)

2. Numerical data: the character is "value", followed by "specific value"

//Timestamp: the character is "time", followed by "specific timestamp "

//Alarm and recovery identification: the characters are "state", followed by "alarm" or "recovery" (alarm is alarm data, recovery is recovery data)

//Historical data identification: the character is "retransmit", followed by "enable"

The data collected during the network disconnection will be temporarily stored in the device, and will be republished when the network is recovered. It is identified by the "retransmit" character, indicating historical data. (Need to enable MQTT data retransmission function in the configuration software)

Payload data format in device subscription message

(The topic of the King Pigeon 2.0 platform downstream publish message is called "device serial number/sensor ID", so the device subscribe topic needs to add the wildcard "/"+" in order to receive the data sent by the platform to achieve control)Subscribe topic: device serial number /+ (corresponding to the data filled in the subscribe topic item on the configuration software)

```

{
  "sensorDatas":
  [
    {
      "sensorsId": 211267, //platform sensor ID
      "switcher":1, //data type :value
      "flag":"DO1" // Read and write flag
    }
  ],
}

```



```

"down": "down" //Platform downstream packet identification
}

```

Note:

//Platform sensor ID: the character is "sensorsID", followed by the ID number (ID is automatically generated by the platform)

//Data type and value:

1. Switch-type data: the character is "switcher", followed by "0" or "1" (0 open, 1 closed)

2. Numerical data: the character is "value", followed by "specific value"

//Read and write flag: the character is "flag", followed by "read and write identification of IO data points"

//Downstream packet identification of the platform: the character is "down", followed by "down", which means that this is the downlink data of the platform.

Device I/O data point read and write flag

Data Point	Flag	Type	Description
DO	DOx	Switcher	0 is open, 1 is closed
DI	DIx	Switcher	0 is open, 1 is closed
AI	AIx	Value	True value = original value
Temperature	TEMP	Value	True value = original value
Humidity	HUMI	Value	True value = original value
External power voltage	EXTPWR	Value	True value = original value
DIN0 counter	COUNT	Value	True value = original value
DIN1counter	COUNT1	Value	True value = original value
DIN2 counter	COUNT2	Value	True value = original value
DIN3counter	COUNT3	Value	True value = original value

Note:

“DOx” : DO0、DO1、DO2、DO3 ;

“DIx” : DI0、DI1、DI2、DI3、DI4、DI5、DI6、DI7;

“AIx” : AI0、AI1、AI2、AI3、AI4、AI5.

Mapping register read-write flag

Data	Read&write Flag	Data type	Description
Boolean data	REG64~REG127	Switcher	According to the definition of slave register data
16-bit data type	REG20000~REG20127	Value	According to the definition of slave register data

Note:

Mapping register read and write identification is unified as "REGx" (x is the address of the mapping register)

10. Upgrade Firmware

The device supports upgrade firmware via USB port directly. If you required upgrade, please contact us to discuss and modify the firmware according to you requirements, we can provide the upgraded firmware to you to upgrade them.

11. Cellular Module Upgrade

The device adopt modular structure design, when user local Gsm operator upgrade network, no need to replace the whole hardware, only need to replace inbuilt communication module, easily upgrade Gsm to 3G, or 3G to 4G network.

Cellular Module Upgrade

Users can easily upgrade GSM (or 3G) to 3G/4G, NB-IoT or 5G network.

No need to replace whole device again when local network upgrade, only pick Gsm module out, put a 3G/4G module in, then device can support 3G/4G.

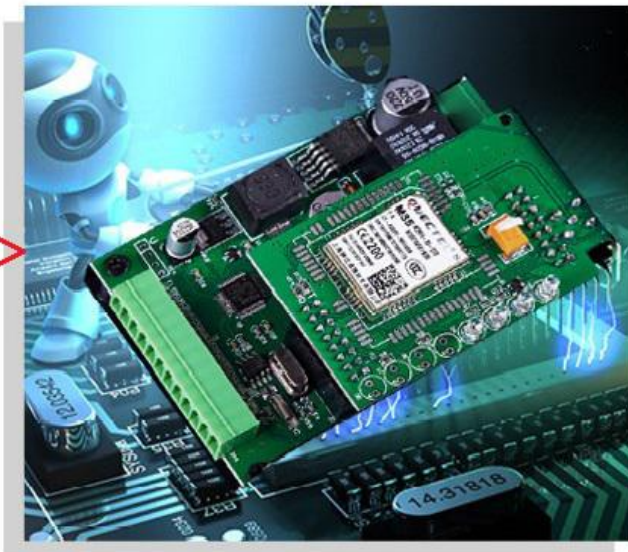

12. Warranty

- 1) This system is warranted to be free of defects in material and workmanship for one year.
- 2) This warranty does not extend to any defect, malfunction or failure caused by abuse or misuse by the Operating Instructions. In no event shall the manufacturer be liable for any alarm system altered by purchasers

The End!

Any questions please help to contact us feel free.

[Http://www.iot-solution.com](http://www.iot-solution.com)